

About PGP-IOx

The PGP-IOx is a two-way wireless transceiver which comprises two general purpose inputs, and two general purpose outputs (PGM). The outputs can be converted into two additional inputs.

Each of the two general purpose inputs can be remotely configured as 'Normally-Closed', 'Normally-Open', 'End-of-Line' or 'Double-End-of-Line' input.

The general purpose outputs are designed for controlling apparatuses having dry-contact control inputs. These general purpose outputs can withstand up to 15VDC (OFF state, open loop) and are capable of sinking up to 1A (ON state, close loop).

The device is tamper protected, both front cover tamper and back mounting tamper.

Operating power is obtained from an on-board 3V Lithium battery. The battery voltage is monitored and reported when low battery conditions are detected.

The device has the following features:

- Dealer lock down
- Two-factor authentication
- Two-way PowerG communication with the control panel
- Front cover and back cover tamper detection
- Periodic supervision message is transmitted automatically to the control panel at regular interval
- Signal strength LED indication during installation
- Discreet transmission of supervision message
- PowerG two-way frequency hopping spread spectrum time-division multiple access (FHSS-TDMA) technology
- Battery reporting
- Low battery indication
- User-selectable operation of auxiliary input as Normally open, Normally closed, End of Line (EOL), or Double EOL

Installation guidelines

The reference to PGP-IOx throughout this manual includes the models PGP-IO8 and PGP-IO9.

- ⚠ **CAUTION:** Risk of explosion if battery is replaced by an incorrect type. Dispose used battery according to manufacturer's instructions
- **Important:** Check the device and the entire alarm system weekly to ensure optimal performance. Have a qualified technician check the entire system at least every three years. Not for use external to the supervised premises.



Figure 1: PGP-IOx

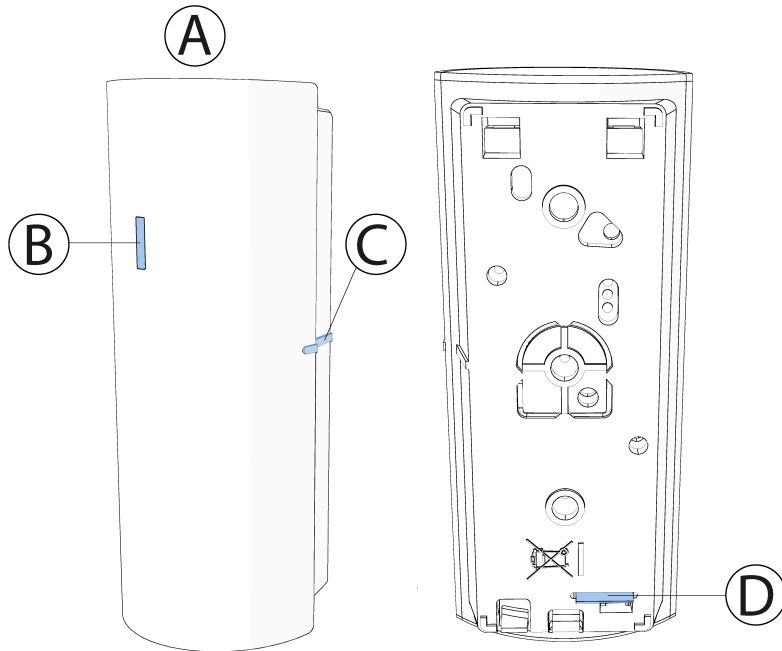

Callout	Description	Callout	Description
A	Device	C	Transmission LED
B	Back of device	D	Pull-tab

For more information refer to section [About PGP-IOx](#) .

Recommended installation locations

Installation locations must be in accordance to: CSA C22.1, Canadian Electrical Code, Part I, Safety Standard for Electrical Installations; CAN/ULC S302, Standard for the Installation, Inspection and Testing of Intrusion Alarm Systems; and CAN/ULC S301, Standard for Signal Receiving Center Intrusion Alarm Systems and Operations, the National Electrical Code, ANSI/NFPA 70. the Standard for Installation and Classification of Burglar and Holdup Alarm Systems, UL 681, and the Standard for Central-Station Alarm Services, UL 827, as applicable.

Install the device on a flat window, wall, or door frame.

Do not install the device in dirty or dusty rooms, near water (for example, kitchen or laundry sinks, bath tubs, wets, basements, or similar), heaters, air conditioning, wall vents, refrigerators, in very high or awkward areas (for example, over a stairwell where it is difficult to reach the device for testing or battery replacement).

Configuring device inputs

1. Press the enroll button until red LED turns on, then release the button. If the device has been converted successfully to a 4-input device, the red LED flashes three times. The device is now ready to be enrolled as 4-input device. The converted device is shown in the panel as Contact+4in . Use the ID 530-XXXX for two input and two output wires. Use ID 106-XXXX for four input wires. In fallback mode (PG2 products), use ID 105-XXXX for two input and two output wires.
2. To convert the device back to 2 inputs and 2 outputs device, press the enroll button until red LED turns on. When red LED is on, release the button. If the device has been converted back successfully to 2 inputs and 2 outputs device, the green LED flashes three times.

- ① **Note:** If the device is already enrolled to the panel, it must be deleted from the panel before re-configuring the device inputs

Enrolling the device

The following steps are relevant for IQ panels. For other panels, refer to the control panel installation manual for the complete set of enrollment instructions and testing procedures.

Verify that the IQ panel software version supports the device. The minimum IQ Panel 4 software version required is 4.6.1.

1. From the **panel** menu, enter the **Settings** menu.
 2. Select **Advanced Settings > Enter Code > Installation > Devices > Security Sensors > Auto Learn Sensor** .
 3. Remove the battery pull-tab to power on the device and begin the auto-enrollment process. If the battery pull-tab is not available or if the device does not automatically enroll, open and close the device cover to trigger the enrollment. Alternatively, press the enroll button until the orange LED turns on.
 4. **Optional:** Select **Add Sensor** to manually enroll device.
 - a. Scan the QR Code on the device box, using the IQ4 camera if available, or see step b.
 - b. Manually enter the device ID, printed on the product label. Use the ID 530-XXXX for two input and two output wires. Use ID 106-XXXX for four input wires. In fallback mode (PG2 products), use ID 105-XXXX for two input and two output wires.
- ① **Note:** If the device has been powered up for more than 48 hours it will be identified by the system only after the device has been reset. The PGP-IOx is enrolled with device ID 530-XXXX or 106-XXXX. In fallback mode it enrolls as WL-IOG PG2 with device ID 105-XXXX.
5. Select the desired zone.
 6. Configure any device parameters that are required.
 7. Mount and test the device. See [Local diagnostics test](#) for information on testing the device.

Configuring the device parameters

1. On the IQ panel, enter the **Installation > Devices > Security Sensors > Edit Sensor**. Select the required configuration as described in the following table:

Table 1: Configuration options

Option	Action
Sensor input	Define the auxiliary hard-wired input. Optional settings: Disabled , End Of Line (EOL) , Double end of line (DEOL) , Auxiliary Normally Open (NO) , Auxiliary Normally Closed (NC) , or Global .
Activation LED	Define whether the alarm LED indication will be activated. Optional settings: LED Enabled (default) and LED Disabled .

Mounting the device using screws

- ① **Note:** Mounting using screws is required for UL/ULC commercial burglary and residential fire type installations. Wall tamper (break-away segment) shall also be enabled.

Figure 2: Internal view

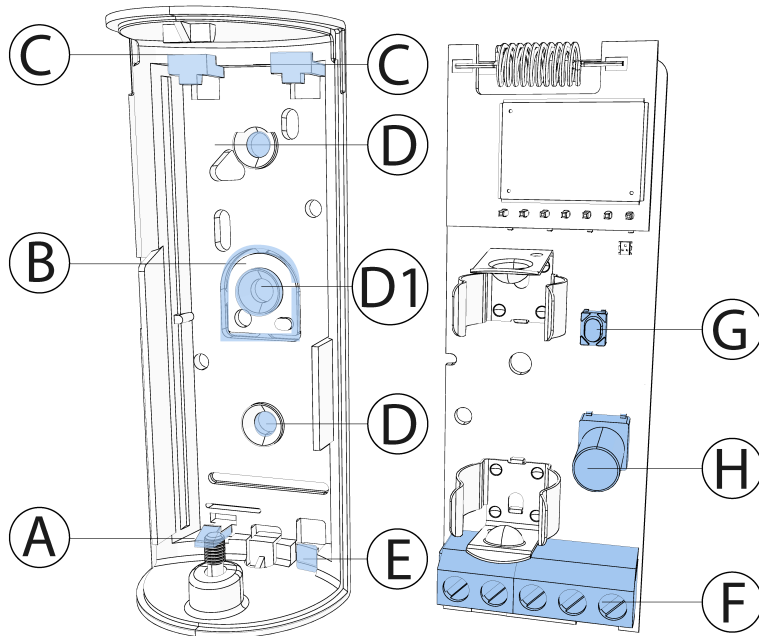

Callout	Description
A	Flexible electronic board retainer
B	Break-away segment
C	Electronic board edge supports
D	Mounting holes
D1	Tamper protection
E	Wiring inlet
F	Terminal block
G	Enroll button
H	Tamper switch

1. To open the device cover, use a screwdriver to loosen the cover screw and separate the base from the cover.

Figure 3: Device cover removal

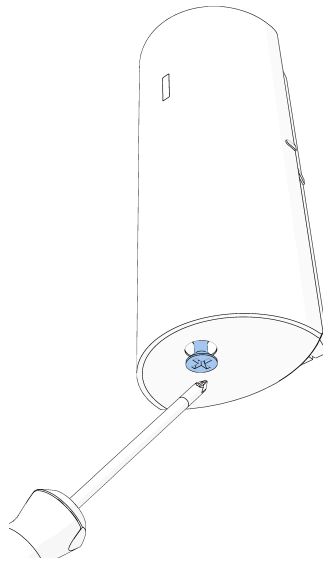

2. Remove the battery.
3. Flex the retainer and remove the electronic board. See B in the following figure.

Figure 4: Removing the electronic board

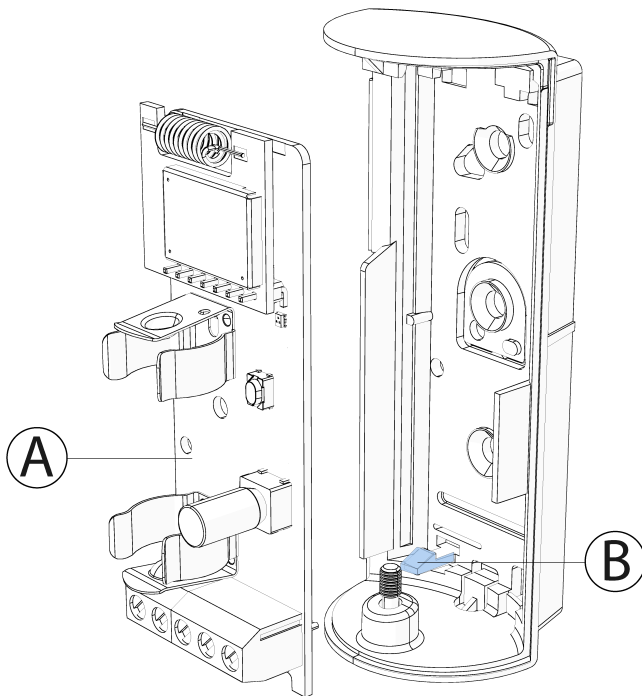

Callout	Description
A	Electronic board
B	Retainer

- Screw the device base on to the chosen surface. See the following figure.

Note:

Make sure to fasten the break-away segment to the frame. If the device is forcibly removed from the wall, this segment will break away from the base, causing the tamper switch to open. See [Figure 5 A](#).

Wall tamper is required for UL/ULC commercial burglary and residential fire installations and EN Grade 2 installations.

Figure 5: Device screw installation

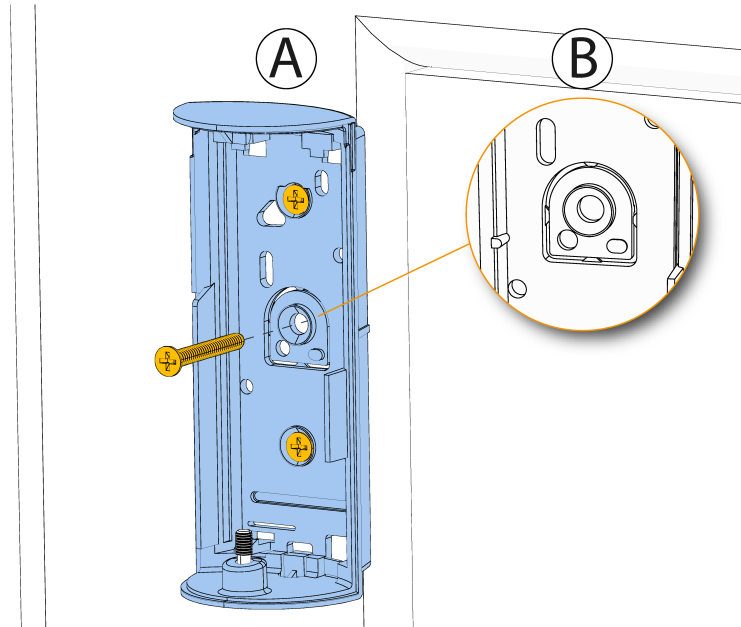

Callout	Description
A	Screwing device base
B	Break-away Segment

- Complete the wiring tasks and the local diagnostics test.

Wiring the input

Note: Depending on panel either two or four inputs are added.

The auxiliary input is programmable as either Auxiliary Disabled, End Of Line (EOL), Double end of line (DEOL), Auxiliary Normally Open (NO), Auxiliary Normally Closed (NC), or Global. The Circuits are Power Limited/Class 2.

If an input is configured as NC type, series connected NC sensor contacts must be used exclusively. An alarm message is transmitted once the loop is opened.

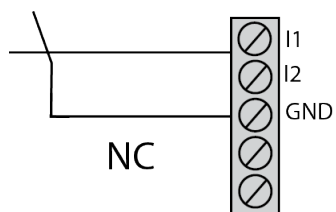
Figure 6: Normally closed

If an input is configured as NO type, parallel connected NO sensor contacts must be used exclusively. An alarm message is transmitted once the loop is closed.

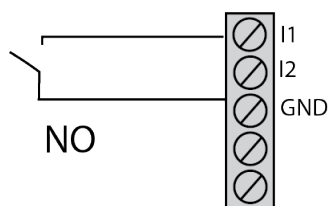
Figure 7: Normally open

If an input is configured as EOL type, NC or NO, sensor contacts can be used, as shown in the figure below. 5.6kΩ* resistor must be wired at the far end of the zone loop. An alarm message is transmitted once the loop is opened or short circuited.

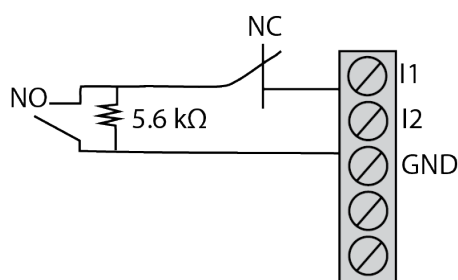
Figure 8: End of line

① **Note:** For UL/ULC Residential/Commercial Burglar Alarm Installations and UL/ULC Residential Fire Installations, use Model EOLR-2. For UL/ULC Residential Fire Installations, only use EOL type configuration.

If an input is configured as DEOL type, two NC sensor contacts can be used as shown in the figure below. Two 5.6kΩ* resistors must be wired at the far end of the zone loop. An alarm message is transmitted once the Alarm switch is opened. A Tamper message is transmitted once the loop is opened or short circuit.

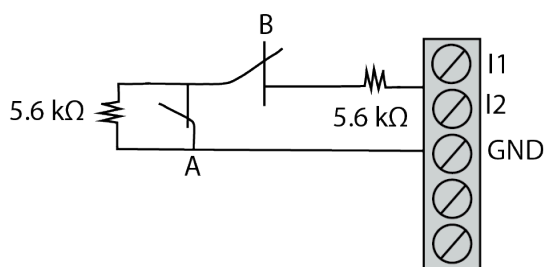
Figure 9: Double end of line

① **Note:** The inputs can be calibrated to work with end-of-line resistors different from 5.6kΩ. Acceptable resistor values range from 2.5kΩ to 12kΩ.

1. Make sure the device is enrolled and configured with the enabled inputs.
2. Check that all inputs are properly wired and set to their requested normal secured state.
3. Press the enroll button until the green LED turns on, then release the button.
4. If the inputs are calibrated successfully, the green LED flashes three times. If the red LED flashes at this point, return to step one.

① **Note:** During calibration, all enabled inputs must be set or wired to a normal secure state; otherwise, the calibration will fail. When the inputs are reconfigured, the calibration value goes back to its factory settings.

The PGP-IOx has by default two inputs and two outputs. The two outputs can be converted to two additional inputs. After the conversion, the PGP-IO x functions as described in the figure below. To convert a PGP-IOx device from 2 inputs and 2 outputs to a 4-input device, complete the following steps.

Figure 10: Wiring four inputs

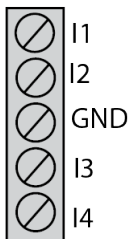

5. Press the enroll button until red LED turns on, then release the button. If the device has been converted successfully to a 4-input device, the red LED flashes three times. The device is now ready to be enrolled as 4-input device. The converted device is shown in the panel as Contact+4in . Use the ID 530-XXXX for two input and two output wires. Use ID 106-XXXX for four input wires. In fallback mode (PG2 products), use ID 105-XXXX for two input and two output wires.
6. To convert the device back to 2 inputs and 2 outputs device, press the enroll button until red LED turns on. When red LED is on, release the button. If the device has been converted back successfully to 2 inputs and 2 outputs device, the green LED flashes three times.

① **Note:** To comply with UL 985 Residential fire applications connect only one UL listed Heat detector.

① **Note:** For UL/ULC Residential/Commercial Burglar Alarm Installations, only use inputs 1 and 2.

① **Note:** Inputs 3 and 4 do not support End Of Line configuration for burglary programming. Inputs 3 and 4 only support Normally Open and Normally Closed configurations for burglary programming.

① **Note:** For UL/ULC installations, the burglary initiating device connected to the initiating circuit must be located within 3 ft, in the same room, as the transmitter if the AUX input is not configured as EOL. For UL/ULC installations, connect only UL/ULC listed devices to the auxiliary wiring input. An alarm message is transmitted once the loop is opened or short circuited.

1. UL985 and ULC-S545 short range RF transmitter application

The device is also UL/ULC listed as a short range RF transmitter for use in Residential fire applications in conjunction with UL/ULC listed fire alarm initiating devices (for example mechanical heat detectors, manual pull stations, etc.). The transmitter shall be installed using provided screws and the back tamper shall be enabled. The heat detector shall be connected to the wired input of the RF transmitter device and the maximum wire length shall not exceed 30 ft (10m). The Reed switch operation shall be disabled. When enrolling the device in the compatible receiver/control panel combination set the AUX input as Smoke/Heat device with EOL supervision in order to transmit a fire alarm when the external input is activated. When the input circuit is

open a trouble condition is generated. An example of compatible initiating devices that could be used in this type of application is the System Sensor UL listed 5600 Series Mechanical Heat Detectors (only models that have self restoring rate of rise sensors 5601P, 5602, 5621, 5622). Refer to the compatible devices installation, testing, and maintenance instructions. Test the self-restoring rate of rise models using a hair dryer or heat gun. Detectors shall be installed as per NFPA72 and/or the local authority having jurisdiction. When testing the ROR element, to prevent the activation of the fixed temperature element, the heat source must not exceed the fixed temperature rating of the detector.

Note: For UL/ULC applications when the external contact is used it is to serve one initiating device only.

Wiring the output

The general purpose outputs are designed for controlling apparatuses having dry-contact control inputs. These general purpose outputs can withstand up to 15 VDC (off state, open loop) and are capable of sinking up to 1 A (on state, closed loop).

Figure 11: Outputs wiring

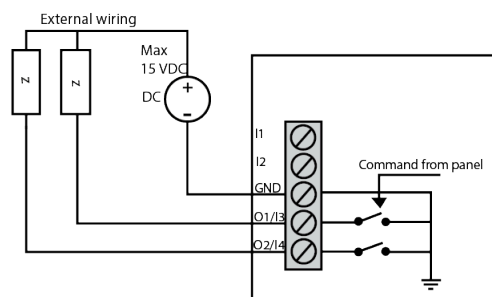

1. Check apparatuses specifications for maximum port voltage and maximum load current.
2. Disconnect the battery.
3. Connect the apparatus to the device.
4. Tighten the connector screws.
5. Insert the battery.

Wiring the terminal block

1. To open the device cover, use a screwdriver to loosen the cover screw and separate the base from the cover. See [Figure 3](#).
2. Use long nose pliers to remove the wiring inlet. See [Figure 12](#).

Figure 12: Removing the knock-out

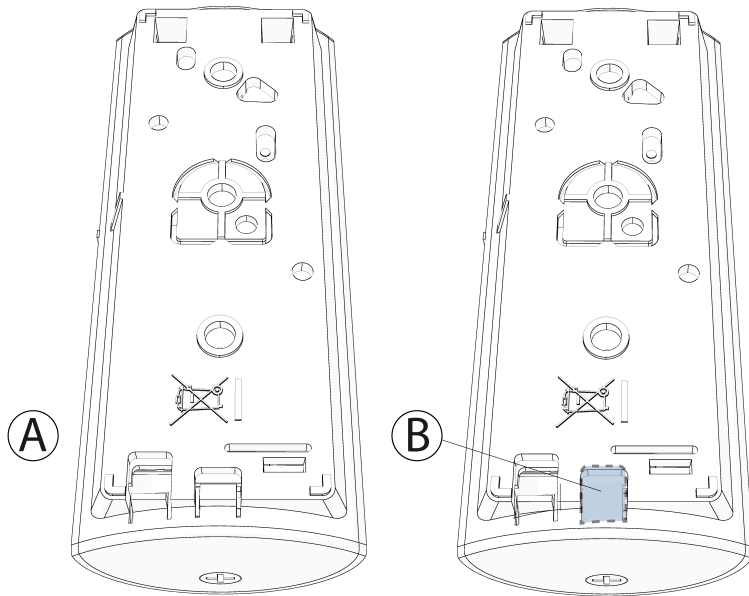

3. Remove the electronic board from the plastic case. See the following figure.

Figure 13: Removing the electronic board

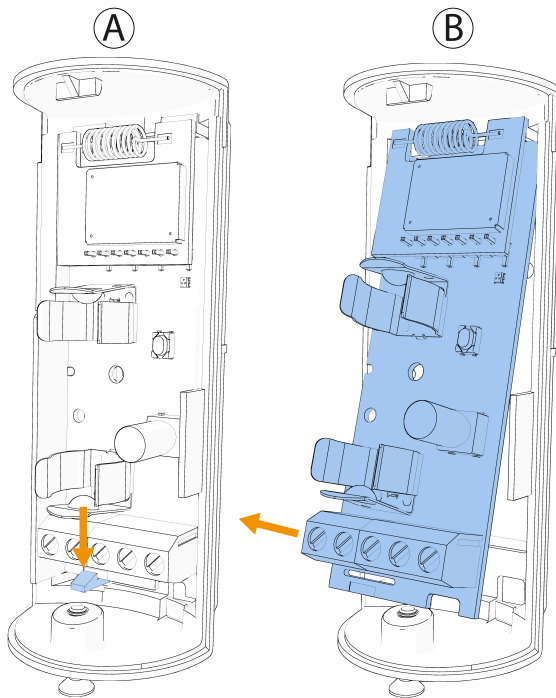

4. Insert the cable into the space where the knock-out was removed from. See the following figure part A.
5. Connect the wires to the terminal block. See the following figure part B.
6. Connect the cable with a screw. See the following figure part C.
7. Verify that the cable is placed in the correct position and adjust if necessary.
8. To reattach the electronic board to the base, flex the retainer and place the electronic board under the electronic board edge supports. See the following figure part D.

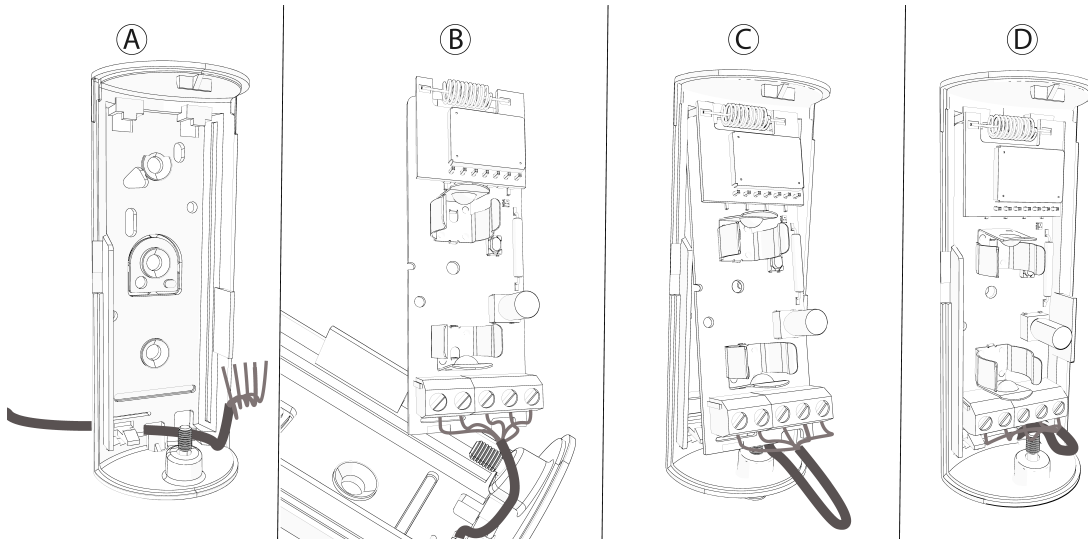
Figure 14: Connecting the cable**Use cases - alarm triggers**

- Self-powered wired sirens
- Long range radio transmitters
- Light / flash activation in case of alarm
- Activation of buzzers
- Fog and smoke generators
- In the event of fire – trip doors (strikes, mags, dog-doors, gates (driveway), overhead doors(mechanical))
- Trip fire suppression systems
- Remote triggers off the universal communicators, for example, 4010 (inputs on the modules)
- Integration with triggers for video system
- Integration with lock-down type of devices
- Integration with access control
- Integration with all call audio systems (evacuation as an example)
- Local siren/strobe notification triggers (24 hour emergency zones)

Use cases - automation

- Manual control of lights
- Opening of automatic driveway and pedestrian gates
- Opening and closing garage door
- (POWERMASTER) Automatic light control based on brightness sensing for gardens, driveways or night lights for perimeter surveillance)
- Lights activation with zone tracking activation
- (POWERMASTER) Thermoregulation with boilers (manual and automatic) with temperature sensor
- Thermoregulation of pellet stoves (manual and automatic)
- Thermoregulation of air conditioners
- Motor control for roller shutters, awnings, darkeners (timed relay required)
- Control Solenoid valves (fire – gas closing, flooding – water closure)
- Remote operation of anti-icing systems of the pipes of mountain houses

- ❗ **Note:** For Incert certified applications the input of the device is not to be used in conjunction with other hardwired intrusion devices.

Replacing the battery

- ⚠ **CAUTION:** Risk of explosion if battery is replaced by an incorrect type. Dispose of used batteries according to the manufacturer's instructions and according to local rules and regulations.

Replace the battery yearly to ensure optimal performance.

1. Remove the device cover. See [Figure 3](#).
2. Remove the battery. See the following figure.
3. Insert the new battery while observing battery polarity. See the following figure.

Figure 15: Battery removal and insertion

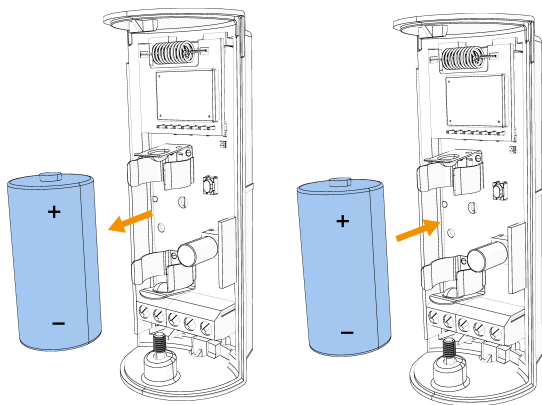

4. Press down on the battery until it fits into place.
5. Close the device cover and fasten the cover screw.

- ❗ **Note:** After restoring a low battery, the system may take up to 5 minutes to clear the trouble. Device support minimum 30 days after low battery message.

Associating an output with a PGM number

The following steps are relevant for IQ panels. For other panels, refer to the control panel installation manual.

1. In the panel menu, select **Settings**.
2. Select **Advanced Settings > Installation > Devices>Security Sensor**.
3. Select **PGM Output Rules**.
4. Find and select the desired device: 530-XXXX or 106-XXXX. Fallback: 105-XXXX or 106-XXXX.
5. Edit rule PGM1 or PGM2.
6. Select **ADD** and modify all parameters as required.
7. Define location.

Local diagnostics test

After power-up or closing the cover, the device automatically enters Test Mode for 15 minutes. To manually enter the devices into Test Mode refer to the Control Panel Installer Guide.

① **Note:** When closing the cover, the device enters local diagnostics mode for about 15 minutes. During this state event detection generates LQT LED indication.

1. Before you start the test, remove the device cover from the base. See [Figure 3](#).
2. Clip the cover onto the device base, return the tamper switch to its normal position, and tighten the cover screw. See the following figure.

Figure 16: Closing the device cover

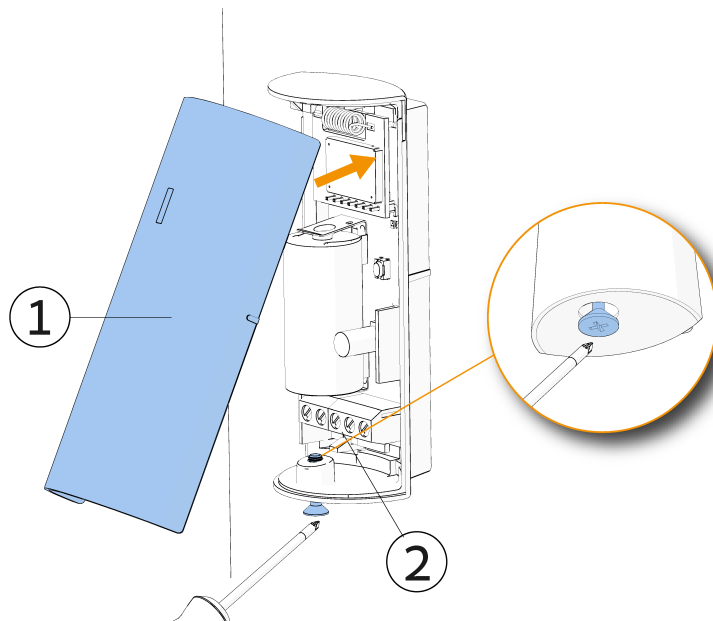

3. After 2 seconds the LED blinks in one of the colors described in the following table. The following table indicates received signal strength indication.

Table 2: Signal strength indication

LED response	Reception
Green LED blinks	Strong
Yellow LED blinks	Good
Red LED blinks	Poor
No blinks	No communication

➤ **Important:** Reliable reception must be assured. Therefore, poor signal strength is not acceptable. If you receive a poor signal from the device, relocate it and re-test until strong signal strength is received.

① **Note:** It is recommended to have a strong signal strength and you must verify the signal strength using the control panel's diagnostic test. For detailed Diagnostics Test instructions, refer to the control panel installer guide.

① **Note:** For UL/ULC installations, only strong signal levels are acceptable.

① **Note:** After installation, verify the product functionality in conjunction with the compatible receivers.

Troubleshooting

For guidance around investigating problems with the device, see below to restore the device to normal operation for details.

Ensure that the input wiring and programming of the zone(s) is correct. See [Wiring the input](#) for details.

Check the signal strength of the device. If signal strength is poor, relocate the device and recheck the signal strength again. See [Local diagnostics test](#) for details.

If necessary, replace the battery with a new CR123A type battery, manufactured by GP or Duracell. See [Replacing the battery](#) for details.

Specifications

Table 3: Specifications

Frequency Band	868 to 869 MHz, 912 to 919 MHz
Maximum Tx power	+14 dBm @ 868 MHz, +14 dBm @ 915 MHz
Modulation	GFSK
Communication protocol	PowerG
Battery type	3 V Lithium CR123A manufactured by GP or Duracell only
Battery life	3 years (typical use) for two inputs and two outputs configuration. 5 years (typical use) for four inputs configuration
Low battery threshold	2.4 V at room temperature 25°C (77°F)
Nominal operating voltage	3 V
Minimum current	2 μ A
Maximum current	70 mA
Operating temperature	-10°C (14°F) to 55°C (131°F) UL/ULC verified range: 0°C (32°F) to 49°C (120°F)
Storage temperature	-20°C (-4°F) to 70°C (158°F) Not UL/ULC evaluated
Relative humidity	Up to 93% non-condensing
Inputs	Wire Resistance: Up to 100 Ω . Wire Capacitance: Up to 1nF (maximum distance of 10 meters from the unit for 20 to 22 AWG cable). EOL supervision resistors (optional): 5.6 K Ω , can be field calibrated within the range of 2.5 K Ω to 12 K Ω . Circuits are power limited/Class 2 wiring.
Outputs	Up to 15VDC (OFF state, open loop, ~20 μ A leakage current). Up to 1A (ON state, close loop, ~0.25V terminals dropout).
Dimensions (LxWxD)	89 mm x 37 mm x 30 mm (3.5 in. x 1.5 in. x 1.2 in.)
Weight (including battery)	53 g (1.9 oz)
Color	White
Auxiliary Input EOL Resistor	5.6 K Ω Note: For UL/ULC Listed applications use Model EOLR-2

Compliance with standards

PGP-IOx complies with the following standards:

PGP-IO9	FCC (912 to 919 MHz): 47CFR part 15.427 ISED (912 to 919 MHz): RSS-247 UL/ULC: UL 985, ULC-S545, UL 1023, ULC S304, UL 2610
PGP-IO8	EN 300220, EN 301489, EN 50130-4, EN 50130-5, EN 61000-6-3, EN 62368-1, EN 50131-1, EN 50131-3, EN 50131-5-3 Grade2, Class II and EN 50131-6 Type C UK: is suitable for use in systems installed to conform to PD6662 at Grade 2 and environmental class II, DD243 and BS8243

PGP-IO8 is certified by KIWA in accordance with EN 50131-1, EN 50131-3, EN 50131-5-3, EN 50131-6, EN 50130-4, EN 50130-5. Security Grade 2 and Environmental Class II.

Simplified EU declaration of conformity

Hereby, Tyco Safety Products Canada Ltd. Declares that the radio equipment type PGP-IO8 is in compliance with Directive 2014/53/EU. The full text of the EU declaration of conformity is available at the following internet address: <http://dsc.com/pdf/2503001>

- ① **Note:** Do not co-locate the antennas used for this product, or operate them in conjunction with any other antenna or transmitter. To comply with FCC and ISED Canada RF exposure compliance requirements, locate the device at a distance of at least 20 cm from all persons during normal operation.

Install the UL/ULC listed models PGP-IO9 in accordance with the Standard for Installation and Classification of Residential Burglar Alarm Systems, UL 1641 and ULC-S302.

This product is to be installed in accordance with Chapter 29 of the National Fire Alarm Code, ANSI/NFPA 72, and ULC-S540.

FCC and ISED Canada Compliance Statement

This device complies with FCC Rules Part 15 and with ISED Canada license-exempt RSS standard(s).

Operation is subject to two conditions:

- (1) This device may not cause harmful interference, and (2) this device must accept any interference that may be received or that may cause undesired operation.

Le présent appareil est conforme aux CNR d'ISED Canada applicables aux appareils radio exempts de licence. L'exploitation est autorisée aux deux conditions suivantes:

- (1) l'appareil ne doit pas produire de brouillage, et (2) l'utilisateur de l'appareil doit accepter tout brouillage radioélectrique subi, même si le brouillage est susceptible d'en compromettre le fonctionnement.*

To comply with FCC Section 1.1310 for human exposure to radio frequency electromagnetic fields and ISED Canada requirements, implement the following instruction:

A distance of at least 20cm. between the equipment and all persons should be maintained during the operation of the equipment.

Le dispositif doit être placé à une distance d'au moins 20 cm à partir de toutes les personnes au cours de son fonctionnement normal. Les antennes utilisées pour ce produit ne doivent pas être situés ou exploités conjointement avec une autre antenne ou transmetteur.

① **Note:** This equipment has been tested and found to comply with the limits for a Class B digital device, pursuant to part 15 of the FCC Rules. These limits are designed to provide reasonable protection against harmful interference in a residential installation. This equipment generates, uses and can radiate radio frequency energy and, if not installed and used in accordance with the instructions, may cause harmful interference to radio communications. However, there is no guarantee that interference will not occur in a particular installation. If this equipment does cause harmful interference to radio or television reception, which can be determined by turning the equipment off and on, the user is encouraged to try to correct the interference by one or more of the following measures:

- Reorient or relocate the receiving antenna.
- Increase the separation between the equipment and receiver.
- Connect the equipment into an outlet on a circuit different from that to which the receiver is connected.
- Consult the dealer or an experienced radio/TV technician for help.

This Class B digital apparatus complies with Canadian ICES-003.

Cet appareil numérique de la classe B est conforme à la norme NMB-003 du Canada.

⚠ **WARNING:** Changes or modifications to this equipment not expressly approved by the party responsible for compliance (DSC.) could void the user's authority to operate the equipment.



UL/ULC notes

Only model PGP-IO9 operating in the frequency band 912-919MHz are UL/cUL listed. PGP-IO9 has been listed by UL/ULC for commercial and residential burglary applications in accordance with the requirements in the Standards UL985 and ULC-S545 as a residential fire RF transmitter (short range). For UL/ULC installations use these device only in conjunction with compatible DSC wireless receivers: IQPanel4, IQ4 Hub, and IQ4 NS. After installation verify the product functionality in conjunction with the compatible receiver used.

Safety Instructions

Read the safety information before you install the equipment.

The detector shall be installed and used within an environment that provides the pollution degree max 2 and over voltages category II in non-hazardous locations, indoor only. The equipment is designed to be installed by SERVICE PERSONS only; (SERVICE PERSON is defined as a person having the appropriate technical training and experience necessary to be aware of hazards to which that person may be exposed in performing a task and of measures to minimize the risks to that person or other persons). The detector is to be installed in an indoor dry location. Exposure to weather or corrosive conditions may damage the unit.

WEEE Product recycling declaration



For information regarding the recycling of this product you must contact the company from which you originally purchased it. If you are discarding this product and not returning it for repair then you must ensure that it is returned as identified by your supplier. This product is not to be thrown away with everyday waste.
Directive 2012/19/EU Waste Electrical and Electronic Equipment.

Limited Warranty

Digital Security Controls ("DSC"), a division of Tyco Safety Products Canada Ltd, a part of the Johnson Controls group of companies ("JCI"), warrants that for a period of 12 months from the date of purchase, the product shall be free of defects in materials and workmanship under normal use and that in fulfillment of any breach of such warranty, JCI shall, at its option, repair or replace the defective equipment upon return of the equipment to its repair depot. This warranty applies only to defects in parts and workmanship and not to damage incurred in shipping or handling, or damage due to causes beyond the control of JCI such as lightning, excessive voltage, mechanical shock, water damage, or damage arising out of abuse, alteration or improper application of the equipment.

The foregoing warranty shall apply only to the original buyer, and is and shall be in lieu of any and all other warranties, whether expressed or implied and of all other obligations or liabilities on the part of JCI. JCI neither assumes responsibility for, nor authorizes any other person purporting to act on its behalf to modify or to change this warranty, nor to assume for it any other warranty or liability concerning this product.

In no event shall JCI be liable for any direct, indirect or consequential damages, loss of anticipated profits, loss of time or any other losses incurred by the buyer in connection with the purchase, installation or operation or failure of this product.

Warning: JCI recommends that the entire system be completely tested on a regular basis. However, despite frequent testing, and due to, but not limited to, criminal tampering or electrical disruption, it is possible for this product to fail to perform as expected.

Important Information: Changes or modifications not expressly approved by JCI could void the user's authority to operate this equipment.

EULA

IMPORTANT READ CAREFULLY: DSC Software purchased with or without Products and Components is copyrighted and is purchased under the following license terms:

This End User License Agreement ("EULA") is a legal agreement between You (the company, individual or entity who acquired the Software and any related Hardware) and Digital Security Controls, a division of Tyco Safety Products Canada Ltd. ("DSC"), the manufacturer of the integrated security systems and the developer of the software and any related products or components ("HARDWARE") which You acquired.

If the DSC software product ("SOFTWARE PRODUCT" or "SOFTWARE") is intended to be accompanied by HARDWARE, and is NOT accompanied by new HARDWARE, You may not use, copy or install the SOFTWARE PRODUCT. The SOFTWARE PRODUCT includes computer software, and may include associated media, printed materials, and "online" or electronic documentation.

Any software provided along with the SOFTWARE PRODUCT that is associated with a separate end user license agreement is licensed to You under the terms of that license agreement.

By installing, copying, downloading, storing, accessing or otherwise using the SOFTWARE PRODUCT, You agree unconditionally to be bound by the terms of this EULA, even if this EULA is deemed to be a modification of any previous arrangement or contract. If You do not agree to the terms of this EULA, DSC is unwilling to license the SOFTWARE PRODUCT to You, and You have no right to use it.

SOFTWARE PRODUCT LICENSE

The SOFTWARE PRODUCT is protected by copyright laws and international copyright treaties, as well as other intellectual property laws and treaties. The SOFTWARE PRODUCT is licensed, not sold.

1. GRANT OF LICENSE. This EULA grants You the following rights:

(a) Software Installation and Use - For each license You acquire, You may have only one copy of the SOFTWARE PRODUCT installed.

(b) Storage/Network Use - The SOFTWARE PRODUCT may not be installed, accessed, displayed, run, shared or used concurrently on or from different computers, including a workstation, terminal or other digital electronic device ("Device"). In other words, if You have several workstations, You will have to acquire a license for each workstation where the SOFTWARE will be used.

(c) Backup Copy - You may make back up copies of the SOFTWARE PRODUCT, but You may only have one copy per license installed at any given time. You may use the back up copy solely for archival purposes. Except as expressly provided in this EULA, You may not otherwise make copies of the SOFTWARE PRODUCT, including the printed materials accompanying the SOFTWARE.

2. DESCRIPTION OF OTHER RIGHTS AND LIMITATIONS

(a) Limitations on Reverse Engineering, Decompilation and Disassembly - You may not reverse engineer, decompile, or disassemble the SOFTWARE PRODUCT, except and only to the extent that such activity is expressly permitted by applicable law notwithstanding this limitation. You may not make any changes or modifications to the Software, without the written permission of an officer of DSC. You may not remove any proprietary notices, marks or labels from the Software Product. You shall institute reasonable measures to ensure compliance with the terms and conditions of this EULA.

(b) Separation of Components - The SOFTWARE PRODUCT is licensed as a single product. Its component parts may not be separated for use on more than one HARDWARE unit.

(c) Single INTEGRATED PRODUCT - If You acquired this SOFTWARE with HARDWARE, then the SOFTWARE PRODUCT is licensed with the HARDWARE as a single integrated product. In this case, the SOFTWARE PRODUCT may only be used with the HARDWARE as set forth in this EULA.

(d) Rental - You may not rent, lease or lend the SOFTWARE PRODUCT. You may not make it available to others or post it on a server or web site.

(e) Software Product Transfer - You may transfer all of Your rights under this EULA only as part of a permanent sale or transfer of the HARDWARE, provided You retain no copies, You transfer all of the SOFTWARE PRODUCT (including all component parts, the media and printed materials, any upgrades and this EULA), and provided the recipient agrees to the terms of this EULA. If the SOFTWARE PRODUCT is an upgrade, any transfer must also include all prior versions of the SOFTWARE PRODUCT.

(f) Termination - Without prejudice to any other rights, DSC may terminate this EULA if You fail to comply with the terms and conditions of this EULA. In such event, You must destroy all copies of the SOFTWARE PRODUCT and all of its component parts.

(g) Trademarks - This EULA does not grant You any rights in connection with any trademarks or service marks of DSC or its suppliers.

3. COPYRIGHT

All title and intellectual property rights in and to the SOFTWARE PRODUCT (including but not limited to any images, photographs, and text incorporated into the SOFTWARE PRODUCT), the accompanying printed materials, and any copies of the SOFTWARE PRODUCT, are owned by DSC or its suppliers. You may not copy the printed materials accompanying the SOFTWARE PRODUCT. All title and intellectual property rights in and to the content which may be accessed through use of the SOFTWARE PRODUCT are the property of the respective content owner and may be protected by applicable copyright or other intellectual property laws and treaties. This EULA grants You no rights to use such content. All rights not expressly granted under this EULA are reserved by DSC and its suppliers.

4. EXPORT RESTRICTIONS

You agree that You will not export or re export the SOFTWARE PRODUCT to any country, person, or entity subject to Canadian export restrictions.

5. CHOICE OF LAW: This Software License Agreement is governed by the laws of the Province of Ontario, Canada.

6. ARBITRATION

All disputes arising in connection with this Agreement shall be determined by final and binding arbitration in accordance with the Arbitration Act, and the parties agree to be bound by the arbitrator's decision. The place of arbitration shall be Toronto, Canada, and the language of the arbitration shall be English.

7. LIMITED WARRANTY

(a) NO WARRANTY

DSC PROVIDES THE SOFTWARE "AS IS" WITHOUT WARRANTY. DSC DOES NOT WARRANT THAT THE SOFTWARE WILL MEET YOUR REQUIREMENTS OR THAT OPERATION OF THE SOFTWARE WILL BE UNINTERRUPTED OR ERROR-FREE.

(b) CHANGES IN OPERATING ENVIRONMENT

DSC shall not be responsible for problems caused by changes in the operating characteristics of the HARDWARE, or for problems in the interaction of the SOFTWARE PRODUCT with non-DSC-SOFTWARE or HARDWARE PRODUCTS.

(c) LIMITATION OF LIABILITY; WARRANTY REFLECTS ALLOCATION OF RISK

IN ANY EVENT, IF ANY STATUTE IMPLIES WARRANTIES OR CONDITIONS NOT STATED IN THIS LICENSE AGREEMENT, DSC'S ENTIRE LIABILITY UNDER ANY PROVISION OF THIS LICENSE AGREEMENT SHALL BE LIMITED TO THE GREATER OF THE AMOUNT ACTUALLY PAID BY YOU TO LICENSE THE SOFTWARE PRODUCT AND FIVE CANADIAN DOLLARS (CAD\$5.00). BECAUSE SOME JURISDICTIONS DO NOT ALLOW THE EXCLUSION OR LIMITATION OF LIABILITY FOR CONSEQUENTIAL OR INCIDENTAL DAMAGES, THE ABOVE LIMITATION MAY NOT APPLY TO YOU.

(d) DISCLAIMER OF WARRANTIES

THIS WARRANTY CONTAINS THE ENTIRE WARRANTY AND SHALL BE IN LIEU OF ANY AND ALL OTHER WARRANTIES, WHETHER EXPRESSED OR IMPLIED (INCLUDING ALL IMPLIED WARRANTIES OF MERCHANTABILITY OR FITNESS FOR A PARTICULAR PURPOSE) AND OF ALL OTHER OBLIGATIONS OR LIABILITIES ON THE PART OF DSC. DSC MAKES NO OTHER WARRANTIES. DSC NEITHER ASSUMES NOR AUTHORIZES ANY OTHER PERSON PURPORTING TO ACT ON ITS BEHALF TO MODIFY OR TO CHANGE THIS WARRANTY, NOR TO ASSUME FOR IT ANY OTHER WARRANTY OR LIABILITY CONCERNING THIS SOFTWARE PRODUCT.

(e) EXCLUSIVE REMEDY AND LIMITATION OF WARRANTY

UNDER NO CIRCUMSTANCES SHALL DSC BE LIABLE FOR ANY SPECIAL, INCIDENTAL, CONSEQUENTIAL OR INDIRECT DAMAGES BASED UPON BREACH OF WARRANTY, BREACH OF CONTRACT, NEGLIGENCE, STRICT LIABILITY, OR ANY OTHER LEGAL THEORY. SUCH DAMAGES INCLUDE, BUT ARE NOT LIMITED TO, LOSS OF PROFITS, LOSS OF THE SOFTWARE PRODUCT OR ANY ASSOCIATED EQUIPMENT, COST OF CAPITAL, COST OF SUBSTITUTE OR REPLACEMENT EQUIPMENT, FACILITIES OR SERVICES, DOWN TIME, PURCHASERS TIME, THE CLAIMS OF THIRD PARTIES, INCLUDING CUSTOMERS, AND INJURY TO PROPERTY.

WARNING: DSC recommends that the entire system be completely tested on a regular basis. However, despite frequent testing, and due to, but not limited to, criminal tampering or electrical disruption, it is possible for this SOFTWARE PRODUCT to fail to perform as expected.

Website: www.dsc.com

Tech. support: 1-800- 387-3630