

INSTALLATION MANUAL

Golsys IQ Panel 1.4.3 Software



The Golsys IQ Panel is a 7" touchscreen built with an Android operating system, providing full security and home control functionality in an easy to use interface.

INCLUDED IN BOX



IQ Panel



Power
Supply

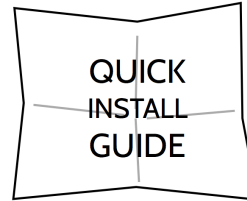

SUPPORT



QUESTIONS?

Contact us at
techsupport@qolsys.com

ABOUT THIS GUIDE

This document outlines the basic hardware specifications and software directions to install and customize the IQ Panel. Note that the information presented is not comprehensive, but is specifically dedicated to those menus, features, and systems accessible solely to those with the proper installation code. Features accessible to users and installers alike are outlined in the IQ Panel User Guide. The information contained is confidential and proprietary, and is solely owned by Qolsys Inc. Any reproduction, modification or distribution without permission is strictly prohibited.

TABLE OF CONTENTS



CONTENTS

HARDWARE

- 5- Exterior Front
- 6- Exterior Back
- 7- Interior
- 8- Wiring Diagram
- 9- Installing the Back Plate
- 10- Powering the Panel
- 11- Mounting the Hardware

SOFTWARE

- 13- Home Screen Overview
- 14- Header or "Status" Bar
- 15- Footer
- 16- Settings
- 17- Settings Menu

INSTALLATION

- 19- Installation
- 20- Security Account
- 22- Security Sensors
- 23- AutoLearn Sensor
- 24- Add Sensor
- 25- Sensor Types
- 26- Sensor Name
- 28- Chime Type

- 29- Sensor Groups
- 43- Voice Prompt
- 44- Home Control Settings
- 45- Home Control Devices
- 46- Add Device
- 47- Clear Device
- 48- Delete Device
- 49- Remove All Devices
- 50- Rediscover Network
- 51- Neighbor Info
- 52- Counters
- 53- Timer
- 54- Sound
- 56- System Logs
- 57- Upgrade Software
- 58- Siren and Alarms
- 59- Security and Arming
- 61- Camera Settings
- 62- Device List
- 63- IQ2 Devices
- 64- Dual Path

SYSTEM TESTS

- 66- System Tests
- 67- Wi-Fi Test

- 68- Sensor Test
- 69- Cellular Test
- 70- Image Sensor Config
- 71- Home Control Test
- 72- Panel Test
- 73- IQ2 Devices Test

CUSTOMIZATION

- 75- System Settings
- 76- How to Connect Wi-Fi
- 77- Weather
- 78- Photo Frame
- 80- Load Images from SD Card
- 81- Photo Frame Settings
- 82- Dealer Contact
- 83- Custom Names
- 84- Edit Chimes
- 85- User Management
- 86- Load Help Videos

TROUBLESHOOTING

- 88- About
- 91- Upgrade Software Using Wi-Fi
- 92- Automatic Software Updates
- 93- Software Update Via SD Card
- 94- Power Down
- 95- Panel Reboot
- 96- Hard Reboot
- 97- Panel Test
- Troubleshooting
- 100- System Monitor
- 101- Cannot Load Help Videos

LEGAL

- 102- Important Information

SPECIFICATIONS

- 105- Specifications

HARDWARE

EXTERIOR FRONT

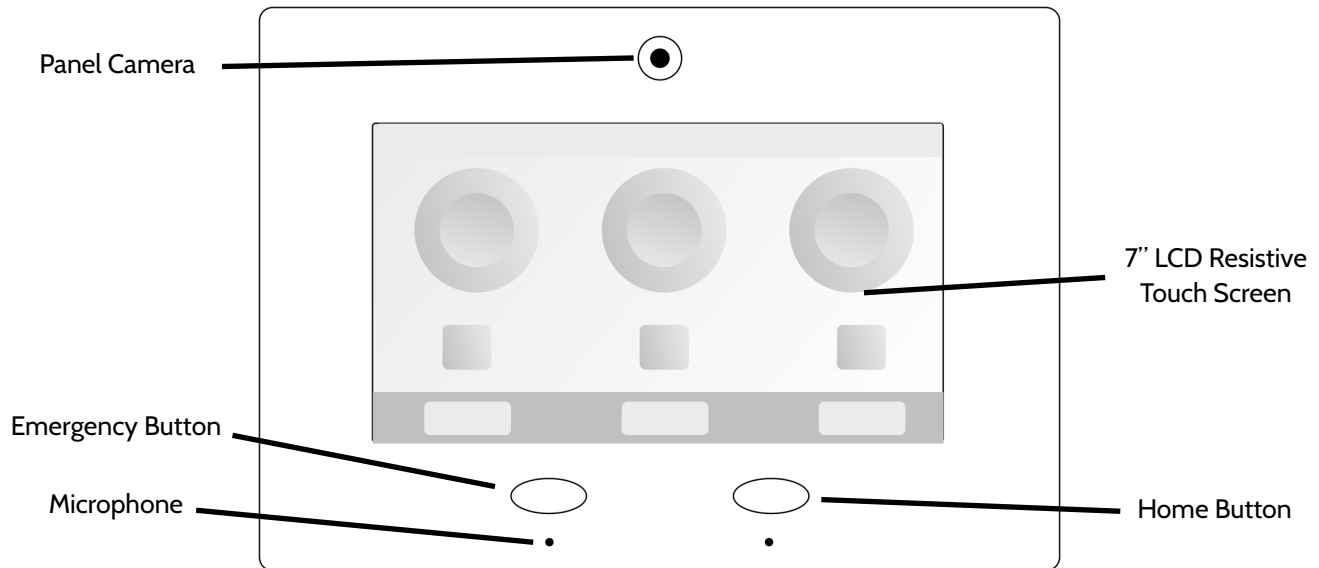

EXTERIOR BACK

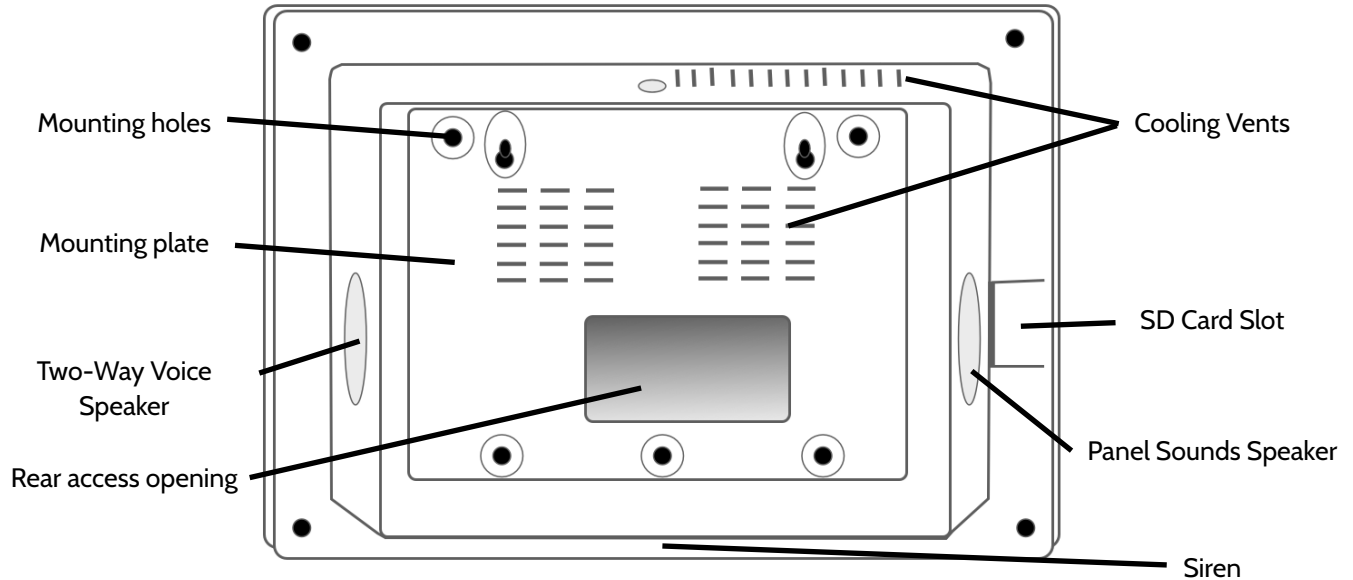

INTERIOR

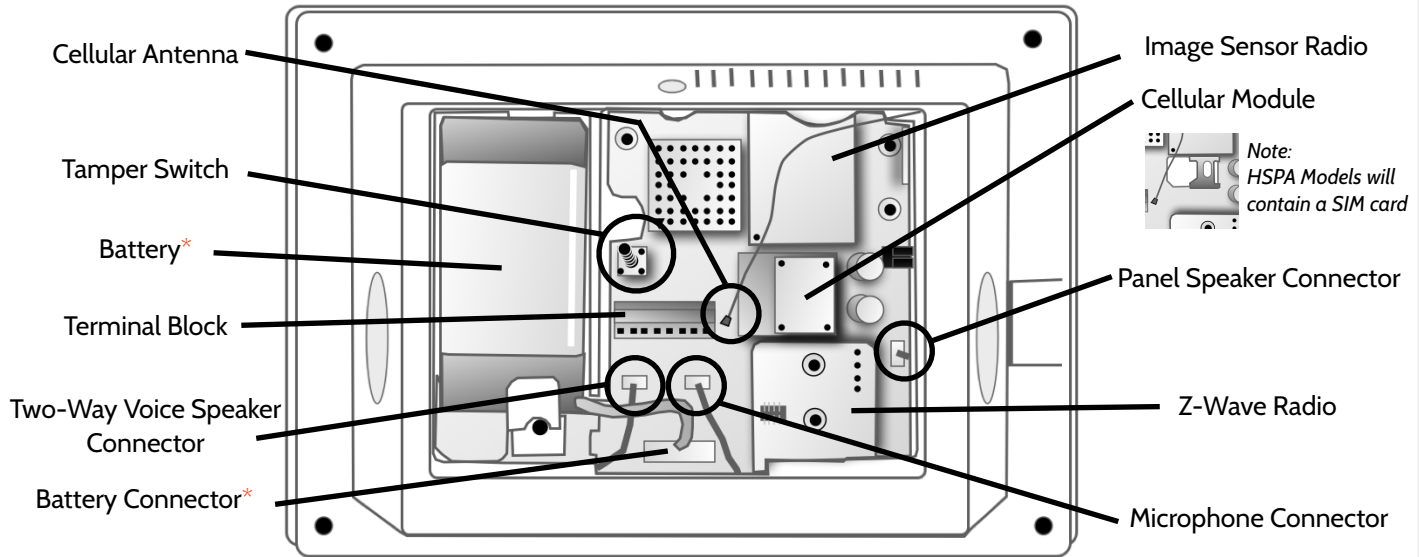

***CAUTION**

The battery should NEVER be disconnected without following proper power-down procedures (page 94)
Failure to comply may result in data corruption, panel failure, and a void of the manufacturer's warranty

WIRING DIAGRAM

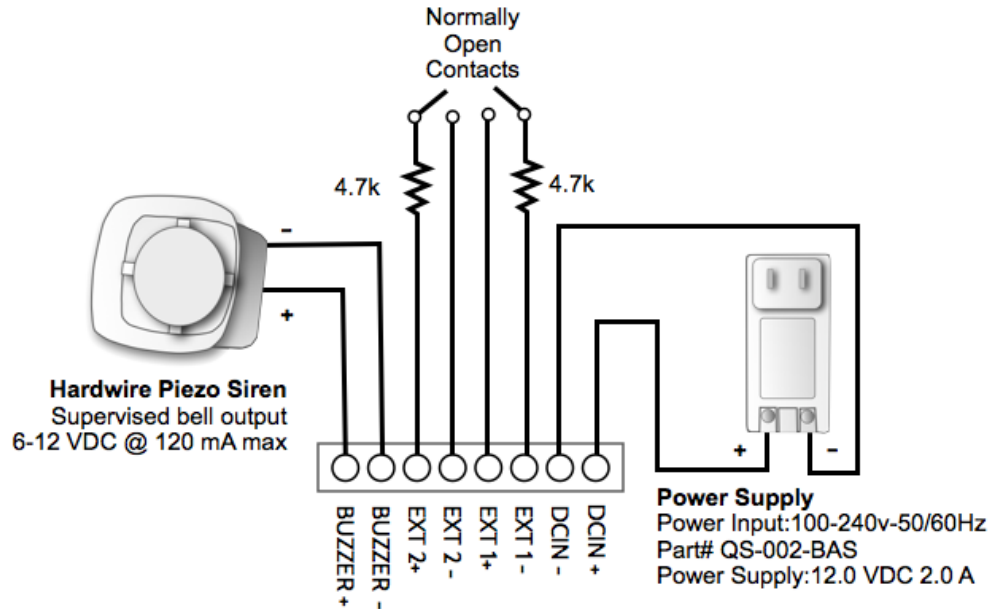

INSTALLING THE BACK PLATE

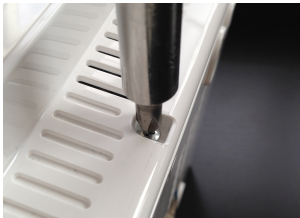

Remove the retainer screw and place in a safe location



Remove the back plate from the panel by pulling downward from the top



Secure one corner of the plate in the desired location, be sure to position rear access opening over the location of your wire



Ensure the plate is level and secure to wall with appropriate mounting hardware (*not provided*)

POWERING THE PANEL



Hang the panel's suspension strap on the hook mounted to the back plate.

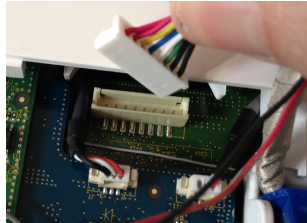

Plug in battery connector

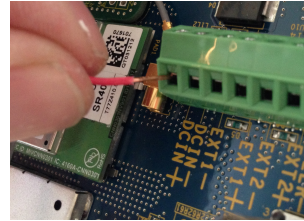

Connect power supply wire to terminal block.
Red- DCIN +
Black- DCIN-

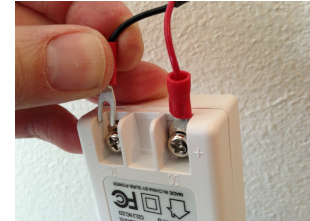

Connect the wire to Power Supply terminals.
Red- Positive
Black- Negative

CAUTION: Once connected, **DO NOT** unplug the battery without following proper power down procedures (page 94). Disconnecting the battery may result in data corruption or panel failure and a void of the manufacturer warranty.

IMPORTANT: To ensure proper power at the panel, 18AWG wire, no longer than 25 feet, should be used between the Panel and the Power Supply.

IMPORTANT: Reversing polarity on these wires may cause damage to the IQ Panel.

MOUNTING THE HARDWARE



Fasten provided power supply bracket to receptacle, (upside down for Decora style plugs). Then snap-in power supply.

WARNING: DO NOT CONNECT TO A SWITCHED OUTLET, GFI OR A HIGH VOLTAGE RECEPTACLE



Slide bottom of panel up to the back plate and tilt upward until it snaps in place.



Replace retainer screw and tighten



Once connected to primary power, panel should power up within 30-45 seconds

SOFTWARE

HOME SCREEN OVERVIEW

The home screen is divided into three sections. The header shows the date, time and is color coded to show current status. The primary user interface contains the panel apps, and the footer holds settings, help, and the dealer contact portal.

Header or
"Status" Bar



Primary
User
Interface



PRESS TO ARM



WEATHER



CAMERA



STATUS



HOME CONTROL



APPS

Footer or
"Help" Bar



SETTINGS



HELP



CONTACT US

FIND IT

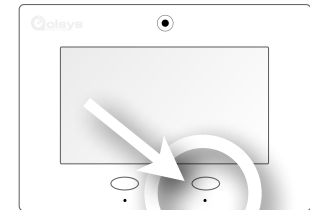

Home

HEADER OR “STATUS” BAR

The header or “Status” bar shows the date, time and is color coded to show the current system status.



Green LED when disarmed
Red LED when armed

The panel’s “Panic” and “Home” buttons also illuminate to show panel status. These LED lights will NOT illuminate if the panel is running on battery only



The **green** header is labeled “System Ready – Disarmed” which indicates that all of the sensors are closed and the system is ready to be armed.



The **yellow** header is labeled “System Not Ready – Disarmed” which indicates that one or more of the sensors are tampered or open. Touch the bar to see a list of these sensors.



The **orange** header is labeled “System Armed-Stay Mode” which indicates that non-bypassed doors and windows are armed.



The **red** header is labeled “System Armed-Away Mode” which indicates that ALL non-bypassed sensors are armed.

FOOTER

The footer bar contains Settings, Help and Contact Us (dealer contact portal).

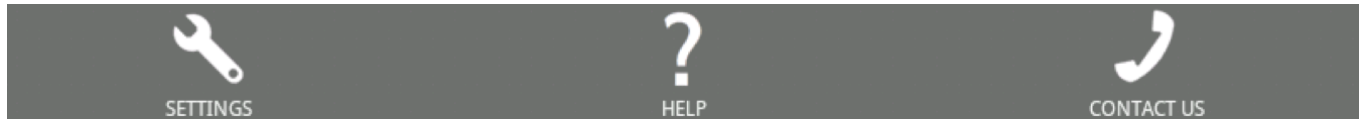

Settings

Access panel installation and customization options. This area requires a valid Dealer, Installer or Master code and provides varied access by user permission level.



Help

Access video tutorials, FAQs, and URLs for other documentation.



Contact Us

Access dealer/security provider contact information including phone numbers, website and e-mail address for support and service. (content pushed automatically from dealer's Alarm.com account)

SETTINGS



To access Settings you must enter a code, however only the Dealer and Installer code has access to installation options. The Master Code does NOT have access to the installation menu.

Please enter user code		
1	2 ABC	3 DEF
4 GHI	5 JKL	6 MNO
7 PQRS	8 TUV	9 WXYZ
Clear	0 +	
Cancel		

Default Dealer Code
2222

Access to all functions to install and customize the panel and peripherals as well as Master Reset and Dealer Contact.

Default Installer Code
1111

Access to all functions to install and customize the panel and peripherals

Default Master Code
1234

Access to limited functions, including editing sensor names, camera app, user management, and connecting to Wi-Fi

FIND IT

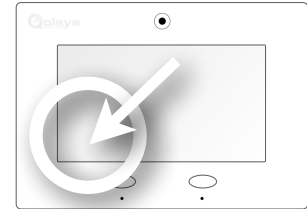

Settings

SETTINGS MENU

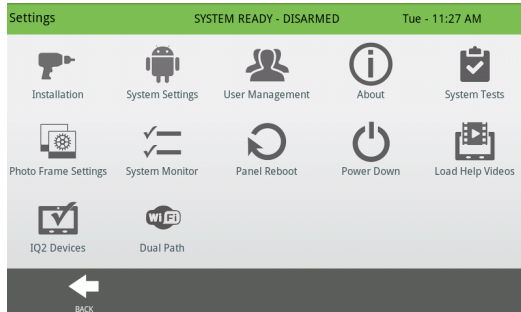

Settings Menu accessed through the Dealer Code:

2222

FIND IT

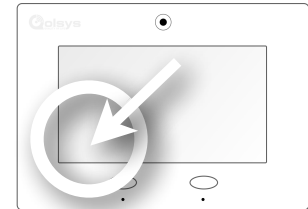

Settings



- Installer Code Access
- Master Code Access

INSTALLATION

INSTALLATION

Installation

SYSTEM READY - DISARMED

Wed - 01:21 PM



Security Account



Security Sensors



Home Control
Settings



Home Control
Devices



Timer



Sound



System Logs



Upgrade Software



Siren and Alarms



Security and Arming



Camera Settings



BACK

FIND IT

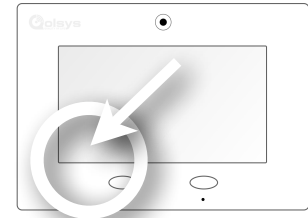

Settings



Installation



Installer Code Access



Master Code Access

SECURITY ACCOUNT

FIND IT

Setting	Default	Description
Account Number	blank	Security provider account number (up to 10 characters)
Power Management	Enabled	An energy-saving function when running on battery power only
Power Management Sleep Timeout	5	Panel initiates power management mode a specified number of minutes after last touch
SIA Power Restoration	Disabled	Turn on or off sensor hold for 60 seconds during power restoration
Loss of Supervisory Signals for Emergency Sensors	4	Select the length in hours (4,12,24) before reporting a loss of supervision on life safety devices.
Loss of Supervisory Signals for Non Emergency Sensors	24	Select the length in hours (4,12,24) before reporting a loss of supervision on security devices.
Loss of AC Power Timeout	3	Select the length in minutes (1-10) before reporting an AC power loss.
Loss of Cell Signal Timeout	30	Select the length in minutes (10-120) before reporting a loss in cellular signal.

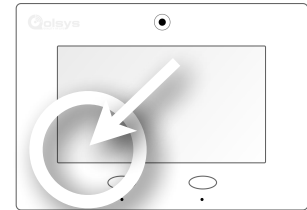

Settings



Installation



Security Account

- Installer Code Access
- Master Code Access

SECURITY ACCOUNT

Setting	Default	Description
SIA Limits	Enabled	When enabled , the range for entry and exit delays is as follows: -Entry delay: 30-240 seconds, Exit Delay: 45-254 seconds When disabled , the range for entry and exit delays are as follows: -Entry delay: 5 to 240 seconds, Exit delay: 5 to 254 seconds
Weather Temperature	F	Select the temperature format. (Fahrenheit or Celsius)
Languages	English	Select a panel language. All settings and menus will change except videos. (English, French and Spanish)
Favourite Languages	English/ Spanish	Select your favourite languages. This setting determines what 2 languages the bi-lingual toggle uses in the Apps section. Favourite 1 is the primary language on the panel, favourite 2 is the secondary language. (English, French and Spanish)
IQ2 Panel	Enabled	Enable or Disable the ability to pair an IQ2 secondary panel.
Jam Detection*	Disabled	When enabled the system can detect when an unusual amount of RF signals are being transmitted leading to a potential panel malfunction. This will report to the central station and handled accordingly.
Jam Detection Local Alarm*	Disabled	When enabled the system will sound a local alarm. "Jam Detection" must be active for this to function properly.
RF Jam Sensitivity Level*	High	Choose between HIGH and LOW sensitivity levels.
Open/Close Reports Allowed For Auto Learn	Disabled	Rather than sending a tamper to auto learn a sensor, enabling this will allow an open/close of the sensor to trigger auto learn

FIND IT

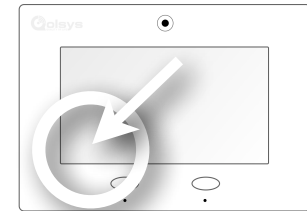

Settings



Installation



**Security
Account**

* Additional options available only through the Dealer Code.

- Installer Code Access**
- Master Code Access**

SECURITY SENSORS



Security Sensors

Add, edit or remove up to 64 security or life safety devices. 5 of which being allocated for image sensors.



Auto Learn Sensor

Pair sensors quickly by tripping or tampering and then editing the information



Add Sensor

Pair sensors manually by typing in a DL code or Serial number



Edit Sensor

Make changes to existing sensors



Delete Sensor

Remove sensor



Sensor Status

Monitor sensor status in realtime.



Sensor Group

Quick reference to all sensor groups and their actions

FIND IT

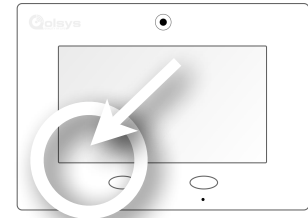

Settings



Installation



Security Sensors



Installer Code Access



Master Code Access

AUTO LEARN SENSOR



1. Select “Auto Learn Sensor”

2. Open and close or tamper a sensor to enroll. Image sensors have a 2 min enrolling window.

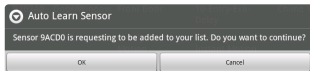

3. Panel will chime and display the sensor’s DL code, select OK to confirm.

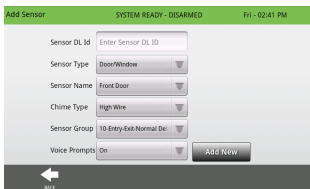

4. Use drop down menus and “smart” filters to program Sensor Group, Chime etc..

5. Select “Add New” to complete and move to the next sensor.

FIND IT

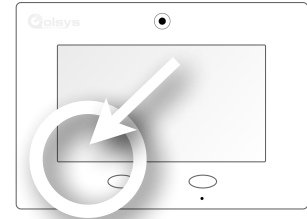

Settings



Installation



Security Sensors



Auto Learn
Sensor



Installer Code Access



Master Code Access

ADD SENSOR



Sensor DL Id	<input type="text" value="Enter Sensor DL Id"/>
Sensor Type	<input type="text" value="Door/Window"/>
Sensor Name	<input type="text" value="Front Door"/>
Chime Type	<input type="text" value="High wire"/>
Sensor Group	<input type="text" value="10-Entry-Exit-Normal Del"/>
Voice Prompts	<input type="text" value="On"/>

Add New

1. Select “Add Sensor” (NOTE: These same fields can be edited later from the “Edit Sensor” app)
2. Tap the field marked “Sensor DL ID” to open the keyboard. Enter the six digit DL code on the back of the device and touch “Done”
3. Choose **sensor type** from list
4. Choose **sensor name** from the list or create a “Custom Name” using the built in keyboard with Text to Speech.
5. Choose **chime type** from list
6. Indicate **sensor group** from list
7. Indicate whether you want **voice prompts** on or off
8. Click “Add New” to save the information and complete the process.

FIND IT

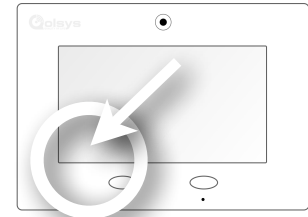

Settings



Installation



Security Sensors



Add Sensor



Installer Code Access



Master Code Access

SENSOR TYPES

When adding or editing security devices you can choose from the following sensor types:

- Door/Window
- Motion
- Glass Break
- Key Fob
- Keypad
- Auxiliary Pendant
- Smoke Detector
- CO Detector
- Hardwire Translator
- Wireless Translator
- Heat
- Water
- Shock Sensor
- Freeze
- Tilt
- Image Sensor
- Door Bell
- Smoke-M
- Door/Window-M

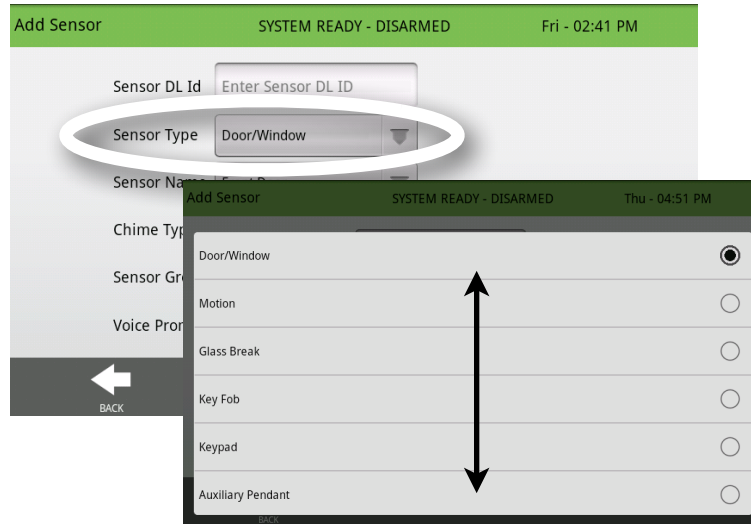

FIND IT

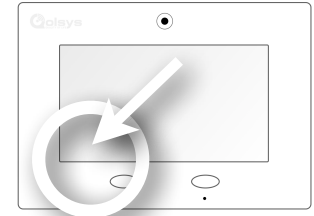

Settings



Installation



Security Sensors



AutoLearn
Sensor



Installer Code Access
Master Code Access

SENSOR NAME

When you select the sensor name field you can choose from a variety of preset sensor names by scrolling up and down or create a custom description.

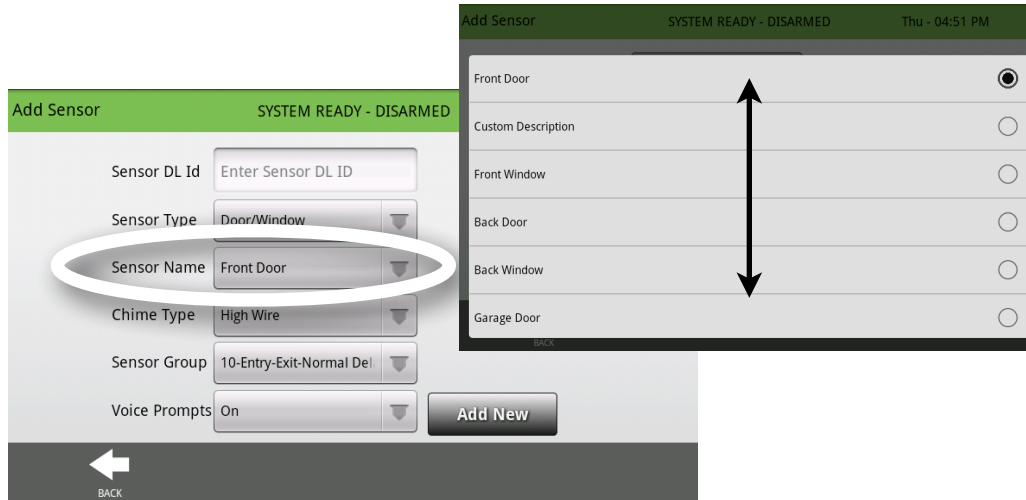

FIND IT

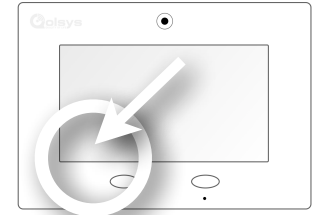

Settings



Installation



Security Sensors



AutoLearn
Sensor



Installer Code Access



Master Code Access

SENSOR NAME: CUSTOM DESCRIPTION

When you select “Custom Description” as your sensor name the android keyboard will appear. Type in the desired name (up to 24 characters, alphanumeric only, no special characters) and click “Done.” The name will appear in the field next to “Sensor Name.”

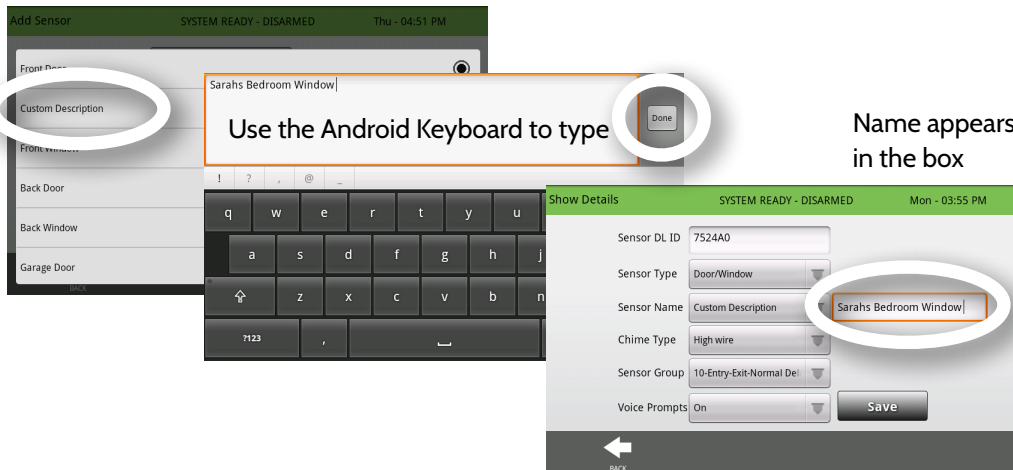

Use the Android Keyboard to type

Name appears in the box

Sensor DL ID: 7524A0
Sensor Type: Door/Window
Sensor Name: Custom Description (Sarahs Bedroom Window)
Chime Type: High wire
Sensor Group: 10-Entry-Exit-Normal De
Voice Prompts: On

Save

FIND IT

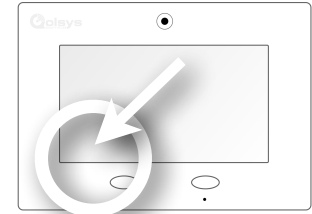

Settings



Installation



Security Sensors



AutoLearn
Sensor



Installer Code Access



Master Code Access

CHIME TYPE

Because of the dynamic nature of the way the IQ panel pairs and understands each individual sensor, you can program each to have a unique chime or even turn chiming off for that individual sensor. To customize your chime for a particular sensor touch the chime type button and choose from the list.

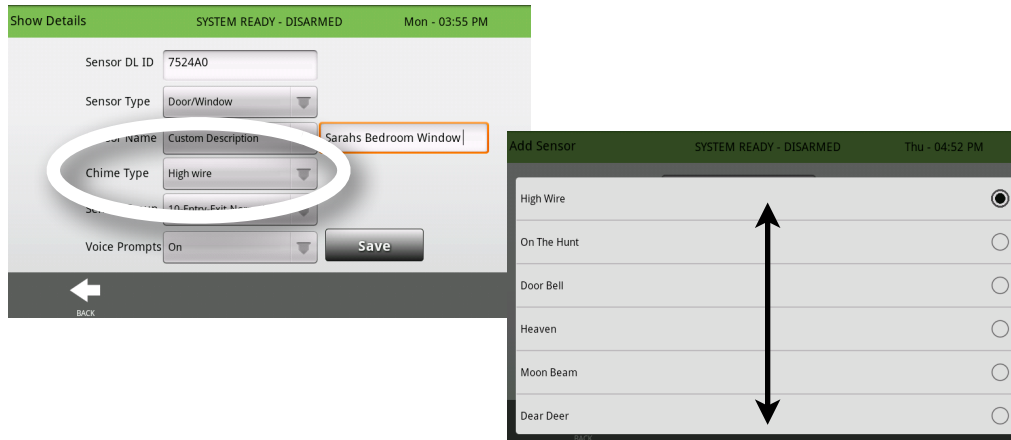

FIND IT

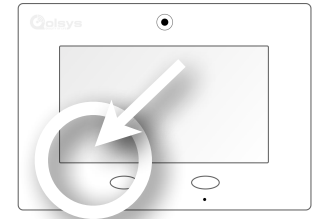

Settings



Installation



Security Sensors



AutoLearn
Sensor



Installer Code Access



Master Code Access

SENSOR GROUP

Customizing the sensor group will change the behavior of the panel. Sensor groups are tied directly to your sensor type, so only the groups available for that type of sensor will be displayed. To edit sensor group, touch the “Sensor Group” button.

You can find a full list of sensor groups on the panel inside the “Sensor Group” app under “Security Sensors.”

You can also find descriptions of how these sensor groups behave on the following pages.

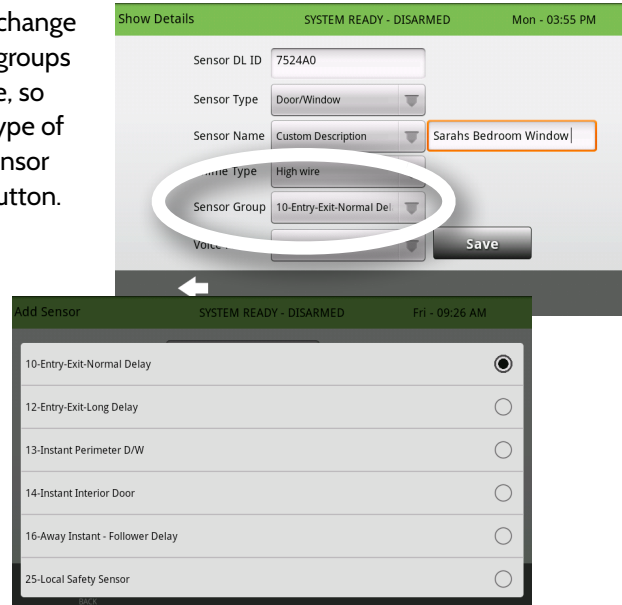

FIND IT

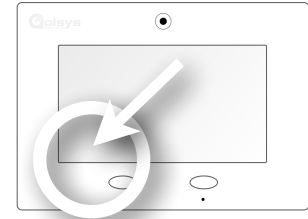

Settings



Installation



Security Sensors



AutoLearn
Sensor



Installer Code Access



Master Code Access

DOOR/WINDOW

GROUP	NAME	SUPERVISED	SCENARIO
10	Entry-Exit- Normal Delay	Y	Gives a period of time to exit the home or to disarm the panel when returning before sounding the alarm.
12	Entry-Exit- Long Delay	Y	Gives a period of time to exit the home or to disarm the panel when returning before sounding the alarm. This can be a separate delay from the “normal delay”.
13	Instant Perimeter D/W	Y	Door or window that triggers alarm instantly when system is armed
14	Instant Interior Door	Y	An interior sensor that triggers an alarm instantly while armed to both stay and away. Does not trip if an entry/exit sensor is tripped first.
16	Away Instant- Follower Delay	Y	Interior door that triggers alarm instantly when system is armed to away mode only

DOOR/WINDOW

GROUP	NAME	SUPERVISED	SCENARIO
25	Local Safety Sensor	Y	This sensor does not report or trigger an alarm. This is a chime only sensor when "Safety Sensors" are active, regardless of panel status. Used for medicine cabinets, chemical storage etc.
8	Reporting Safety Sensor	Y	This sensor reports to the central station and triggers an alarm when "Safety Sensors" is active, regardless of panel status.
9	Delayed Reporting Safety Sensor	Y	This sensor reports to the central station and triggers an alarm when "Safety Sensors" is active, regardless of panel status. This sensor has an entry delay.

MOTION/IMAGE SENSOR

GROUP	NAME	SUPERVISED	SCENARIO
17	Away- Instant Motion	Y	Active only when armed to “Away”, and trips instantly when motion is detected. Does not trip if an entry/exit sensor is tripped first.
15	Stay- Instant Motion	Y	Also active when armed to “Stay”, and trips instantly when motion is detected. Does not trip if an entry/exit sensor is tripped first.
35	Stay- Delay Motion	Y	Also active when armed to “Stay”. Triggers an entry delay when motion is detected. Does not trip if an entry/exit sensor is tripped first.
20	Away- Delay Motion	Y	Active when armed to “Away”. Triggers an entry delay when motion is detected. Does not trip if an entry/exit sensor is tripped first.
25	Safety Motion	Y	This sensor does not report or trigger an alarm. This is a chime only sensor when “Safety Sensors” are active, regardless of panel status. Used for medicine cabinets, chemical storage etc.

GLASS BREAK

GROUP	NAME	SUPERVISED	SCENARIO
13	Glass Break	Y	Arms IQ Glass in both “Stay” and “Away” mode
17	Glass Break -Away Only	Y	Arms IQ Glass in “Away” mode only

KEY FOB

GROUP	NAME	SUPERVISED	SCENARIO
1	Mobile Intrusion	N	Worn or carried , the button(s) is/are programmed to trigger a police panic
6	Mobile Auxiliary	N	Worn as a wrist watch or pendant, the button(s) is/are programmed to trigger an auxiliary panic.
4	Fixed Auxiliary	Y	Installed in a fixed location such as night stand, the button(s) is/are programmed to trigger an auxiliary panic.

KEYPAD

GROUP	NAME	SUPERVISED	SCENARIO
0	Fixed Intrusion	Y	Installed in a fixed location such as under a desk, the button(s) is/are programmed to trigger a police panic
2	Fixed Silent	Y	Installed in a fixed location such as under a desk, the button(s) is/are programmed to trigger a silent police panic

AUXILIARY PENDANT

GROUP	NAME	SUPERVISED	SCENARIO
6	Mobile Auxiliary	N	Worn as a wrist watch or pendant, the button(s) is/are programmed to trigger an auxiliary panic.
1	Mobile Intrusion	N	Worn or carried , the button(s) is/are programmed to trigger a police panic
0	Fixed Intrusion	Y	Installed in a fixed location such as under a desk, the button(s) is/are programmed to trigger a police panic
2	Fixed Silent	Y	Installed in a fixed location such as under a desk, the button(s) is/are programmed to trigger a silent police panic
4	Fixed Auxiliary	Y	Installed in a fixed location such as night stand, the button(s) is/are programmed to trigger an auxiliary panic

SMOKE DETECTOR/HEAT

GROUP	NAME	SUPERVISED	SCENARIO
26	Smoke-Heat	Y	Triggers an alarm when sensor detects smoke/rapid rise in heat.

CO DETECTOR

GROUP	NAME	SUPERVISED	SCENARIO
34	CO	Y	Triggers an alarm when sensor detects Carbon Monoxide.

HARDWIRE TRANSLATOR

GROUP	NAME	SUPERVISED	SCENARIO
13	Takeover	Y	Triggers an alarm when sensor is tampered in “Stay” or “Away” mode

WIRELESS TRANSLATOR

GROUP	NAME	SUPERVISED	SCENARIO
13	Translator	Y	Triggers an alarm when sensor is tampered in “Stay” or “Away” mode

WATER

GROUP	NAME	SUPERVISED	SCENARIO
38	Water Sensor	Y	Triggers an alarm when sensor detects presence of water

Please note: When selecting “Water” you will see two additional options under “Sensor Sub-Type”
 For IQ TempH2O & the IQ Flood select “Multi-Function-1”, for all others, select “Flood-2”

SHOCK SENSOR

GROUP	NAME	SUPERVISED	SCENARIO
13	Shock-Glass-Break	Y	Arms and trips IQ Shock Sensor immediately when armed to both “Stay” and “Away”
17	Glass-Break-Away Only	Y	Arms and trips IQ Shock Sensor immediately when armed only to “Away”.

Please note: When selecting “Shock” you will see two additional options under “Sensor Sub-Type”
 For IQ Shock select “IQ Shock”, for all others select “Other Shock”

FREEZE

GROUP	NAME	SUPERVISED	SCENARIO
52	Freeze	Y	Triggers an alarm when sensor detects low temperatures

TILT

GROUP	NAME	SUPERVISED	SCENARIO
12	Entry-Exit- Long Delay	Y	Triggers alarm after “long delay” expires. Arms with both “Stay” and “Away.”
10	Entry-Exit- Normal Delay	Y	Triggers alarm after “normal delay” expires. Arms with both “Stay” and “Away”
25	Garage Tilt- Safety Tilt	Y	This sensor does not report or trigger an alarm. This is a chime only sensor when “Safety Sensors” are active, regardless of panel status. Great for detached garage/shops.

DOOR BELL

GROUP	NAME	SUPERVISED	SCENARIO
25	Local Safety Sensor	Y	This sensor does not report or trigger an alarm. This is a chime only sensor when “Safety Sensors” are active, regardless of panel status. great to automate with Image Sensor and notifications etc.

SMOKE-M

GROUP	NAME	SUPERVISED	SCENARIO
26	Smoke-Heat	Y	Triggers an alarm when sensor detects smoke or a “rapid rise of heat”. Use ONLY with Qolsys multi-sensor smoke.

DOOR/WINDOW-M (For use only with Multi-function Door/Window Sensors)

GROUP	NAME	SUPERVISED	SCENARIO
10	Entry-Exit- Normal Delay	Y	Gives a period of time to exit the home or to disarm the panel when returning before sounding the alarm.
12	Entry-Exit- Long Delay	Y	Gives a period of time to exit the home or to disarm the panel when returning before sounding the alarm. This can be a separate delay from the “normal delay”.
13	Instant Perimeter D/W	Y	Door or window that triggers alarm instantly when system is armed
14	Instant Interior Door	Y	An interior sensor that triggers an alarm instantly while armed to both stay and away. Does not trip if an entry/exit sensor is tripped first.
16	Away Instant- Follower Delay	Y	Interior door that triggers alarm instantly when system is armed to away mode only

DOOR/WINDOW-M (For use only with Multi-function Door/Window Sensors)

GROUP	NAME	SUPERVISED	SCENARIO
25	Local Safety Sensor	Y	This sensor does not report or trigger an alarm. This is a chime only sensor when "Safety Sensors" are active, regardless of panel status. Used for medicine cabinets, chemical storage etc.
8	Reporting Safety Sensor	Y	This sensor reports to the central station and triggers an alarm when "Safety Sensors" is active, regardless of panel status.
9	Delayed Reporting Safety Sensor	Y	This sensor reports to the central station and triggers an alarm when "Safety Sensors" is active, regardless of panel status. This sensor has an entry delay.

VOICE PROMPT

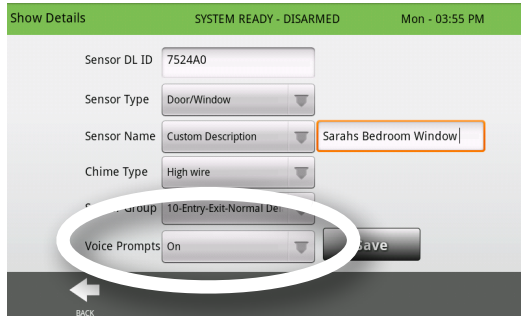

Voice prompts announce the sensor name when the sensor is opened or tripped.*

For door/window sensors, voice prompts are defaulted to “On”. For most other sensors the default is “Off.” To change this simply touch the Voice Prompt button and make the desired adjustment (on/off).

With the IQ Panel you can toggle each of these on or off for each individual sensor, leaving voice prompts on some doors while turning them off on others.

**NOTE: Sensors programmed as “Safety Sensors” will also audibly report when they have been closed.*

FIND IT

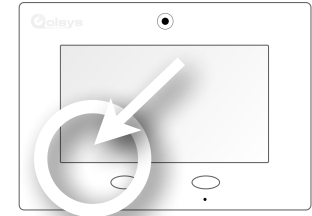

Settings



Installation



Security Sensors



AutoLearn
Sensor



Installer Code Access



Master Code Access

HOME CONTROL SETTINGS

Home Control Settings allow an installer to set a maximum number of Z-Wave devices allowed on the IQ Panel in all categories.

Setting	Default	Description
Thermostats	3	Maximum number of supported Thermostats is 5
Smart Sockets	5	Maximum number of supported IQ Smart Sockets is 18
Lights	5	Max number of supported Z-Wave light modules is 30
Door Locks	6	Maximum number of supported Z-Wave Door Locks is 6
Other Devices	5	Maximum number of misc Z-Wave devices is 10
Allow Master Code Z-Wave Settings	Disabled	Allow Master User Code to access Z-Wave Settings
Allow Master Code Z-Wave Management	Disabled	Allow Master User Code to access Z-Wave device installation settings
Z-Wave	Enabled	Activate or deactivate Z-Wave radio

FIND IT

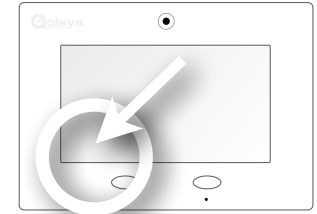

Settings



Installation



Home Control Settings



Installer Code Access



Master Code Access

HOME CONTROL DEVICES

FIND IT



Home Control Devices

Add, Edit, Clear and remove Z-Wave peripherals in Home Control Devices.



Add Device

Pair new devices



Edit Device

Make changes to existing devices



Clear Device

Clears or resets the memory of a Z-Wave device. (Requires you touch the "Pair" button on the device)



Delete Device From Panel

Remove a Z-Wave device from the IQ Panel's memory (does not require you to have the device)



Remove All Devices

Delete all Z-Wave devices from the IQ Panel's memory



Rediscover Network

Re-establishing connection to devices on the Z-Wave network.



Neighbor Info

Displays which neighboring Z-Wave devices help establish a connection to the panel.



Z-Wave Counters

Shows # Z-Wave commands by category

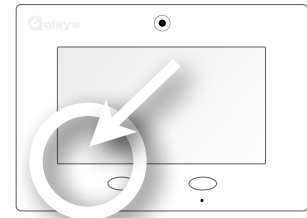

Settings



Installation



Home Control
Devices



Installer Code Access



Master Code Access

ADD DEVICE



1. Select “Add Device”



2. Touch “Pair”

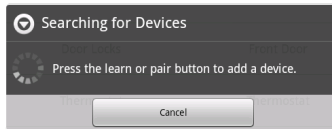

3. Press the “Pair” or “Learn” button on the device when the message appears. *(see individual device documentation for instructions on button location)*

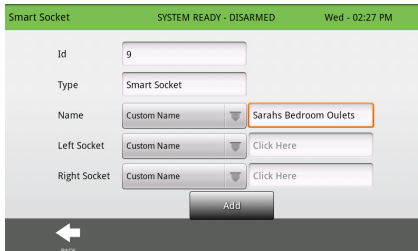

4. Adjust the sensor information by touching the fields and making the appropriate selections.

5. Click “Add” to save the information and complete the process. (Adjustments can be made later from “Edit Device” app)

FIND IT

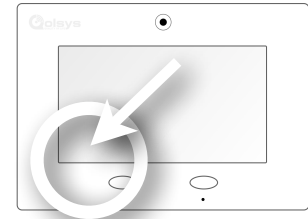

Settings



Installation



Home Control
Devices



Add Device



Installer Code Access



Master Code Access

CLEAR DEVICE



Clears Z-Wave device from a network, whether it was enrolled with another controller previously or the IQ Panel.



Touch
“Clear Device”

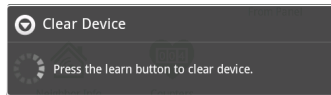

Panel will start sending a
“Clear” signal



Press
“Pair” or “Learn”
button on device*

Panel returns to
Home Control
Device menu
when complete

**Note: each Z-Wave device is different, and not all devices have a hard button to pair or learn. Refer to your device’s installation manual for specifics on pairing or learning.*

FIND IT

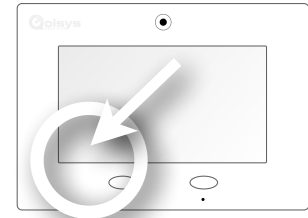

Settings



Installation



Home Control
Devices



Clear Device



Installer Code Access



Master Code Access

DELETE DEVICE FROM PANEL



Deletes Z-Wave device from the panel. This does not clear the device's memory. Before adding the device to another network see instructions on how to "Clear" a Z-Wave device.



Touch
"Delete Device
From Panel"

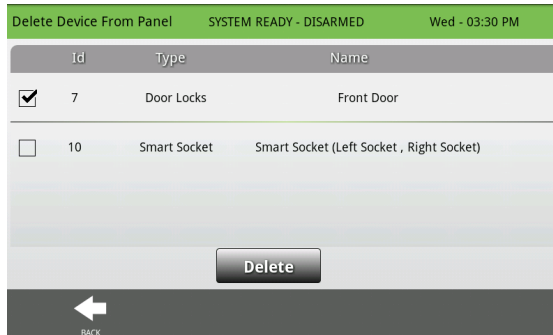

Check the boxes next to the device(s) you want to delete



Touch "Delete"

FIND IT

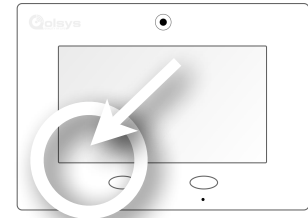

Settings



Installation



Home Control
Devices



Delete Device
From Panel



Installer Code Access



Master Code Access

REMOVE ALL DEVICES



Deletes all Z-wave devices from the panel and resets the panel's Z-Wave controller.

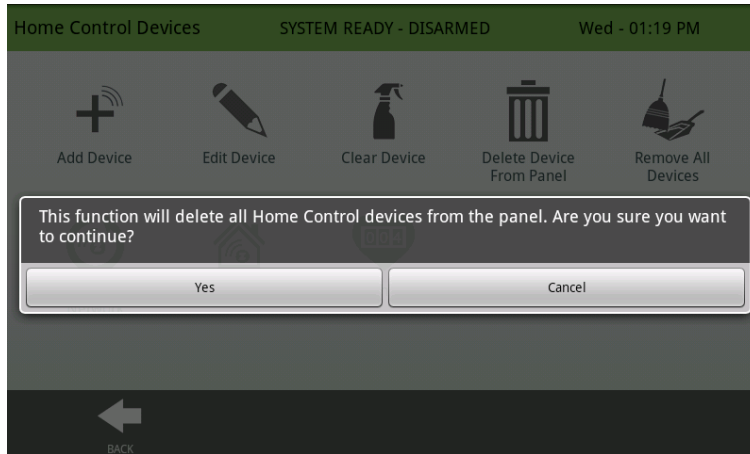

Touching "Remove All Devices" brings a confirmation pop-up asking you to confirm your decision to remove all devices.

FIND IT

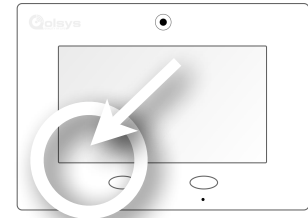

Settings



Installation



Home Control Devices



Remove All Devices



Installer Code Access



Master Code Access

REDISCOVER NETWORK



Rediscover network if a Z-Wave device has been moved, removed or added to the panel. This helps remap and optimize the Z-Wave mesh network.

Check the box next to the device(s) you want to rediscover

<input checked="" type="checkbox"/>	Id	Name	Status
<input checked="" type="checkbox"/>	10	Smart Socket	

Touch "Rediscover"



When complete the status will log date and time of completed rediscovery

<input type="checkbox"/>	Id	Name	Status
<input type="checkbox"/>	10	Smart Socket	Rediscovery ended Today, 4:03 pm

FIND IT

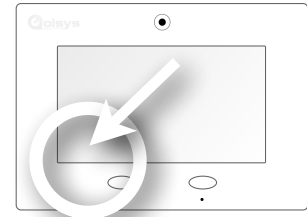

Settings



Installation



Home Control Devices



Rediscover Network



Installer Code Access



Master Code Access

NEIGHBOR INFO



Neighbor info shows which devices depend on another to connect to the panel. This information can help you determine when a repeater may be needed. The more neighbors a device has the more paths it has to communicate with the panel.

Neighbor Info		SYSTEM READY - DISARMED	Wed - 01:16 PM
Id	Name	Neighbor Info	
4	Back Door		
5	Front Door		
6	Thermostat		
7	TV Smart Socket		
8	Shelf Smart Socket		

Neighbor nodes for Back Door (4)

- 7 : TV Smart Socket
- 8 : Shelf Smart Socket
- 9 : Bedrom Socket 2

Touch "View" next to any device and a pop-up will appear listing it's "Neighbor Nodes"

FIND IT

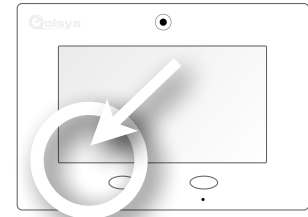

Settings



Installation



Home Control
Devices



Neighbor Info



Installer Code Access



Master Code Access

COUNTERS



Counters shows commands sent to Z-Wave devices. Acknowledged (“Aked”) commands are good. A large amount of Failed commands signifies that the network isn’t very efficient or that devices may be out of range. Try rediscovering the network or adding additional devices.

COUNTER	DESCRIPTION
Aked commands no auto route	Command was successful and acknowledged by the sensor; it did not use the normal automatic Z-Wave network route to execute the command for this device (command was re-routed on the Z-Wave network in order to succeed)
Aked commands auto route	Command was successful and acknowledged by the sensor; it used the normal automatic Z-Wave network route to execute the command for this device.
Failed commands network failed	Not possible to transmit data because Z-Wave network is busy (jammed). Command failed to execute.
Network failed	Not possible to transmit data because Z-Wave network is busy (jammed). Command failed to execute
Network not idle	Auto-routed command failed because Z-Wave network is not yet stable. Command failed to execute.
Network no route	Auto-routed command failed because there is no successful Z-Wave network route to the device. Command failed to execute

FIND IT

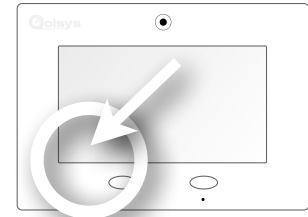

Settings



Installation



Home Control Devices



Counters



Installer Code Access



Master Code Access

TIMER



Change entry and exit delay lengths in the “Timer” app.

Setting	Default	Description
Normal Entry-Exit Delay	Entry: 30 Exit: 60	Entry Delay: How much time users have to enter their code after opening a door programmed as an Normal Entry/Exit delay door When SIA Limits enabled: 30 to 240 seconds When SIA Limits disabled: 05 to 240 seconds
Long Entry-Exit Delay	Entry: 100 Exit: 120	Exit Delay: How much time users have to exit the location before the panel arms itself. When SIA Limits enabled: 45 to 254 seconds When SIA Limits disabled: 05 to 254 seconds

FIND IT

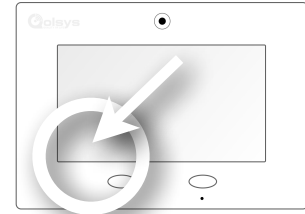

Settings



Installation



Timer



Installer Code Access



Master Code Access

SOUND



The IQ panel sound settings can be found here as well as inside the “apps” section of the panel on the home screen. Master Code has access to this section as well as installer code.

Setting	Description
Volume	Controls the master volume for the entire panel and all its audible functions (except siren) including tones, videos, voice chimes, etc
Edit Chimes	Allows you to select from various chimes for each individual device.
Voice Settings	Indicates whether the panel should “speak.” Sensors, Panel messages, Safety Sensors, and home control device actions can all be toggled independently. <i>(unchecking a box disables the individual feature, unchecking the primary box disables all)</i>
Chime Settings	Indicates whether the panel should emit tones/beeps. Sensors, Panel and Safety Sensors can all be toggled independently. <i>(unchecking box disables feature)</i>

FIND IT

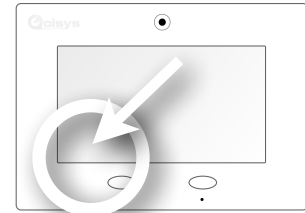

Settings



Installation



Sound



Installer Code Access



Master Code Access

SOUND

Setting	Description
All Trouble Beeps	Toggles all sensor and panel trouble beeps on or off
Sensor Low Battery	Panel sounds when a sensor's battery is low. Chime type and frequency are set below.
Sensor Tamper Beeps	Panel sounds when a sensor is tampered. Chime type and frequency are set below.
Panel Trouble Beeps	Panel sounds when tampered or opened. Chime type and frequency are set below.
Edit Trouble Beep Chimes	Select the chime type for Sensor Low Battery, Sensor Tamper, and Panel Tamper.
Trouble Beeps Timeout	determines the amount of time between each trouble beep. Length can be set between 3-60 mins. (default is 60 mins)

FIND IT

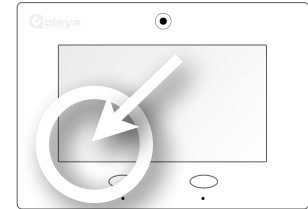

Settings



Installation



Sound



Installer Code Access



Master Code Access

SYSTEM LOGS



System logs allow the panel to send non-customer identifying information to the server for troubleshooting and bug identification.

Setting	Default	Description
Upload logs to the server	<i>Requires manual push</i>	Tell the panel to begin uploading a history of it's activity to the server. This information is used to troubleshoot bugs and diagnose panel problems. The panel will upload any logs saved in it's memory
Auto Upload Logs	Disabled	Automatically upload the system's log to the servers every 2 hours
Log Level	Debug	<p>Tell the panel how much information to record in log files.</p> <p>No log output: No information recorded Fatal: Record fatal or severely problematic information only Error: Record all errors and fatal issues Warn: Record warnings, errors, and fatal issues Info: Record all generic, non-customer related information Debug: Record diagnostic messages, Info, Warnings, Errors, and Fatal issues Verbose: Record all non-customer identifying information</p>

FIND IT

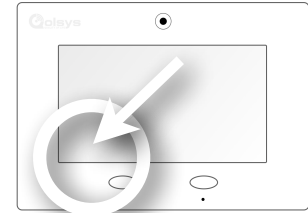

Settings



Installation



System Logs



Installer Code Access



Master Code Access

UPGRADE SOFTWARE



Upgrade the panel software using Wifi, Cellular or an SD Card.

Setting	Description
Delete all Sensors and Devices	Erases all security sensors and Z-Wave devices from the panel.
Master Reset*	Erases all content and settings and restores panel to factory defaults
Reset Panel With Last Backup Image*	The panel will be restored with the most recent backup image used.
Upgrade Using Network	Search the network for updates and install new software
IQ2 Panel Upgrade Using Network	Search the network for updates and install new software for IQ2 secondary tablets paired with the primary
Upgrade Using SD Card	Search an inserted SD Card for updates and install new software
Patch Tag	A code corresponding to a specific software update on the server.
Automatic Upgrade	Allow the panel to update it's software as new versions become available
Automatic Upgrade Interval	Determines interval IQ Panel will look for software updates. (Default 24 hrs)

FIND IT

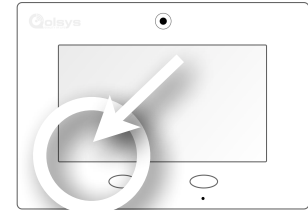

Settings



Installation



Upgrade Software

* Additional options available only through the Dealer Code.



Installer Code Access



Master Code Access

SIREN AND ALARMS

Setting	Default	Description
Disable Siren	Disabled	Turn internal piezo siren (and external siren, if connected) on or off. This will not disable panics.
Siren Annunciation	Disabled	Panel siren pauses periodically to announce which locations have triggered the alarm.
Fire Verification	Disabled	When disabled, fire alarm is triggered with a single fire event from smoke detector. When enabled, panel requires two fire events from smoke detector (one detector twice or two detects once each)
Severe Weather Siren Warning	Enabled	When enabled, siren will sound when the panel receives a severe weather alert. When disabled, panel will use severe weather chime
Dialer Delay	:30	Amount of time (in seconds) before panel will attempt call to central station after an alarm event is triggered When SIA Limits enabled: :15 to :45 seconds When SIA Limits disabled: :05 to :254 seconds
Siren Timeout	4 min	Determine how long before siren stops sounding during an alarm event (4 minutes to 8 minutes)
Water/Freeze Siren	Enabled	When enabled, siren will sound when a water or freeze detector is triggered. When disabled, the panel emits a "water" tone.
Allow Master Code To Access Siren and Alarms	Disabled	Allow the master code to access these features and settings

FIND IT

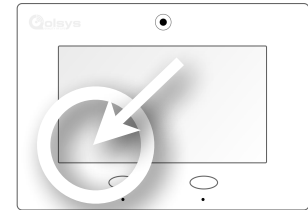

Settings



Installation



Siren and Alarms



Installer Code Access



Master Code Access

SECURITY AND ARMING

FIND IT

Setting	Default	Description
Dealer Code*	2222	Code to access all options
Installer Code	1111	Code to access installer options only
Duress Authentication	Disabled	Toggle whether or not to allow duress codes
Secure Camera	Disabled	Require user code to access camera app
Secure Delete Images	Enabled	When enabled, a code is required to delete disarm and image sensor photos.
Secure Arming	Disabled	Require user code for arming panel
Refuse Arming When Battery Low	Disabled	Will not allow panel to arm if battery is low (below 30%)
Auto Bypass	Enabled	Toggle whether or not to bypass open or tampered sensors automatically
Auto Stay	Enabled	If panel is armed "Away" but a delay door is not opened, the panel assumes you are still home and changes arming to "Stay" mode
Arm Stay No Delay:	Enabled	Arm stay immediately with no countdown timer

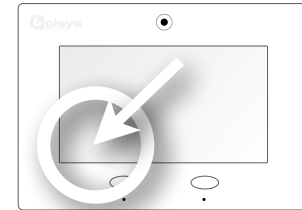

Settings



Installation



Security and Arming

* Additional option available only through the Dealer Code.



Installer Code Access



Master Code Access

SECURITY AND ARMING

Auto Exit Time Extension	Enabled	Automatically extend countdown timer if delay door is opened during countdown process a second time
Keyfob Instant Arming	Enabled	When enabled, turns off exit and entry delays if keyfob is used to arm the system.
Allow Master Code to Access Security and Arming	Disabled	Allow the master code to access these features and settings

FIND IT

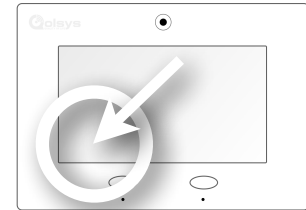

Settings



Installation



Security
and Arming

- Installer Code Access
- Master Code Access

CAMERA SETTINGS

Setting	Default	Description
Disarm Photos	Enabled	When enabled, the built-in camera will take a single photograph when a user disarms the panel. When disabled, the panel will not capture images upon disarm.
Alarm Photos	Enabled	When an alarm is triggered the panel will take 2 photos. One when the alarm has been triggered and the second at the end.
Allow Master Code to Access Image Settings	Disabled	Allow the master code to access these features and settings

FIND IT

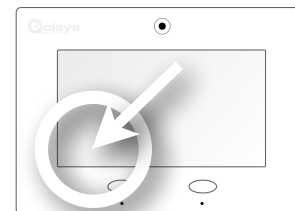

Settings



Installation



Camera Settings



Installer Code Access



Master Code Access

DEVICE LIST*



DEVICE LIST

Shows device specific information for programmed Home Control devices.

Device List				SYSTEM READY - DISARMED	Wed - 09:48 AM
Id	Type	Group	Name		
2	Light	None	Light	<input type="button" value="Info"/>	

←
BACK

By pressing "Info" you will find the following information for that selected device.

Product Info
Protocol Info
Application Info
Supported Command Class

FIND IT

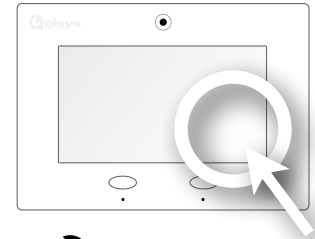

Settings





Device List

* Additional option available only through the Dealer Code.

IQ2 DEVICES



Up to 3 IQ2 secondary tablets can be paired with the IQ Panel.

IQ2 Devices				
SYSTEM READY - DISARMED				
Fri - 10:09 AM				
No	Device Name	IP Address	Status	Actions
65	IQ2	192.168.0.129	Active	<input type="button" value="Ping"/>  

To add a new IQ2 device:

- 1- Touch "Add New"
- 2- Name the device
- 3- Enter the IP Address* located in "More" then "About" on the IQ2 secondary tablet)
- 4- Touch "Save"

IQ2 Device

Device Name

IP Address

**Note: Both the primary and IQ2 secondary must be connected to the same wi-fi network*

FIND IT

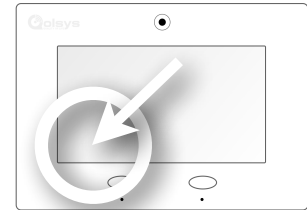

Settings



IQ2
Devices



Installer Code Access
Master Code Access

DUAL PATH



When enabled, dual path connectivity allows the IQ Panel to use both cellular and Wi-Fi radios for signals and communication simultaneously.

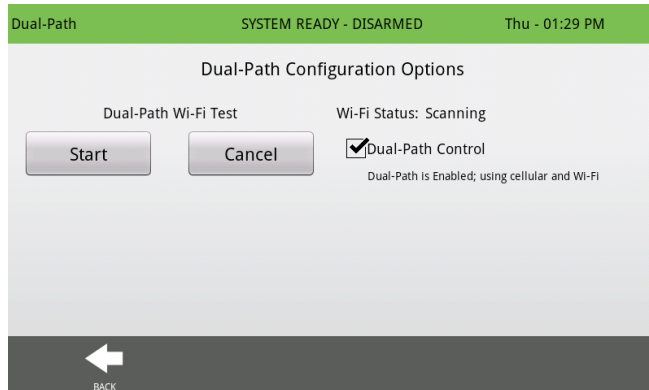

By default Dual-Path Control is enabled. To disable, “un-check” the box.

You can also run a Wi-Fi test to ensure that the Dual Path is connecting properly. Unlike the standard Wi-Fi test (which checks connection to the router) the panel will check its connection all the way back to Alarm.com.

**Note: The IQ Panel must be connected to a wi-fi network to enable Dual Path*

FIND IT

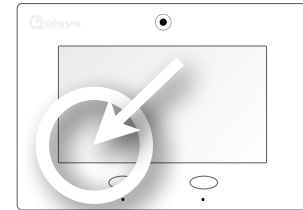

Settings



Dual Path



Installer Code Access
Master Code Access

SYSTEM TESTS

SYSTEM TESTS



System Tests

There are several tests you can run to ensure the system is operating properly.



Wi-Fi Test

Test the panel's connection to the wireless (Wi-Fi) network



Sensor Test

Test the panel's communication with individual security sensors



Cellular Test

Test the panel's connection to the cellular network



Image Sensor Config

Test the panel's connection to Image Sensors



Home Control Test

Test the panel's communication with individual Z-Wave devices



Panel Test

Runs through a full diagnostic of every panel system



IQ2 Devices Test

Runs a connectivity test with connected IQ2 secondary tablets.

FIND IT

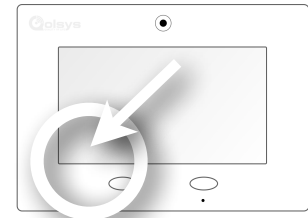

Settings



System Tests



Installer Code Access



Master Code Access

WI-FI TEST



Wi-Fi Test

The Wi-Fi test checks the IQ panel's connection to your network. Before running this test, be sure to connect the panel to the network. See "customization" section for directions on connecting to Wi-Fi.

To perform a Wi-Fi Test, touch the "Run" button.

Test Name	Test Result	Test Time	
Wi-Fi			<input type="button" value="Run"/>

A successful test will result in a "pass" and indicates the date and time of the test.

Test Name	Test Result	Test Time	
Wi-Fi	Pass (72 Mbps)	01:42 pm, Jul 02,2014	<input type="button" value="Run"/>

Note: If test fails, please check your Wi-Fi settings.

FIND IT

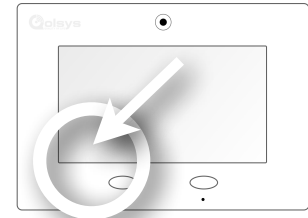

Settings



System
Tests



Wi-Fi Test

- Installer Code Access
- Master Code Access

SENSOR TEST



Sensor Test

The panel can test its connection and communication to the individual security sensors. Before running this test there must be at least one security sensor paired with the system.

Sensors connected to the panel will appear on the screen. Tamper or open a sensor to test. (refer to individual sensor documentation for instructions if needed).

The panel will audibly report and display test results for the sensor being tested.

Excellent	3+ RF packets received
Pass	1 - 2 RF packets received
No Signal	No RF packets received

No	ID	Name	Result	Last Run Time
1	FB88A0	Front Door	Pass	10:37 AM, May 08, 2015
2	A007A0	Back Door	Excellent	10:37 AM, May 08, 2015

FIND IT

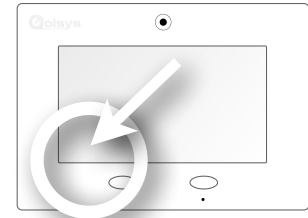

Settings



System Tests



Sensor Test



Installer Code Access



Master Code Access

CELLULAR TEST



Cellular Test

Test the panel's built-in cellular radio connection. You must first activate the radio through alarm.com prior to this test.

To begin the test press "Start" and watch for the results on the screen.

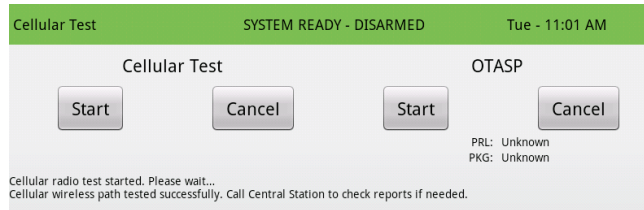

OTASP

The OTASP function is used to register the built in CDMA module with the Verizon network. This should already have been completed at the factory and if attempted will generate a pop up warning. The OTASP option will not appear on a HSPA panel.

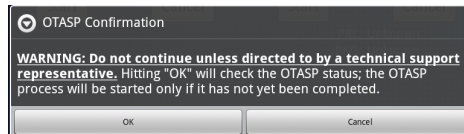

FIND IT

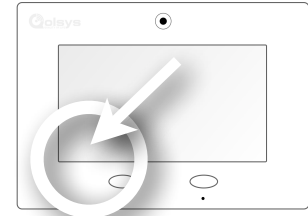

Settings



System Tests



Cellular Test



Installer Code Access



Master Code Access

IMAGE SENSOR CONFIG



Image Sensor Config

Test the image sensor's connectivity with the panel to ensure they are communicating properly and are able to take photos.

Choose an Image Sensor to Test:

Number of Image Sensors: 2	Daughterboard Information
View settings for:	Firmware version: 104.2
60 -- Piano Room IS <input type="button" value="View"/>	MAC: Unknown
61 -- Girls Bedroom IS <input type="button" value="View"/>	Status: Talking
	Library loaded: Yes

Select the desired Image Sensor by touching "View" next to its name



Touch "Sensor Tests"

Select the test you want to run:

PIR Test <small>Click the button below to start a PIR test. This test will help you to confirm whether or not the PIR (passive infrared) detector on the Image Sensor is working properly.</small> <input type="button" value="Start PIR Test"/>	Installer Peek-In <small>Click the button below to request an installer peek-in on this Image Sensor. The peek-in will not count towards your monthly upload limit.</small> <input type="button" value="Request Peek-In"/>
---	---

PIR Test checks the motion sensor

Request Peek In tests the camera (results appear in the Camera App and on the customer's Alarm.com)

FIND IT

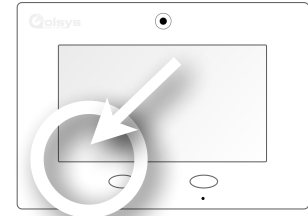

Settings



System Tests



Image Sensor Config



Installer Code Access



Master Code Access

HOME CONTROL TEST



Home Control Test

Test the connection between the panel and enrolled Z-Wave devices to ensure they are communicating properly.

To perform a Home Control Test, touch the “Run” button. A successful test will result in a “Pass” and a time stamp.

Home Control Test		SYSTEM READY - DISARMED		Thu - 10:23 AM	
Id	Type	Status	Test Time	Result	
2	Light	Normal	10:22 AM, May 07, 2015	Pass	<input type="button" value="Run"/>
4	Door Lock	Unreachable	10:23 AM, May 07, 2015	Fail	<input type="button" value="Run"/>

Note: If a test fails, relocate device, change batteries and/or rediscover network.

FIND IT

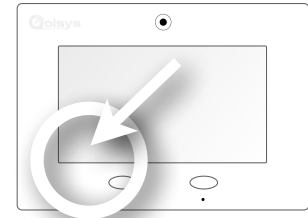

Settings



System Tests



Home Control Test



Installer Code Access



Master Code Access

PANEL TEST



Panel Test

The panel can test all its connections and capabilities with this single, easy to use test. Each test can be initiated manually or use the “Run All” button to run all tests at once.

Panel Test		SYSTEM READY - DISARMED	Wed - 04:43 PM
Test Name	Test Result	Test Time	
Arm-Disarm	Pass	04:43 PM, Jan 07, 2015	Run
Camera			Run
Photos			Run
Help Videos			Run
Run All		Clear All	
 <small>BACK</small>			

Results

Test results are reported as “pass/fail” and are color coded green or red. Under “Test Time” the date and time of the test.

FIND IT

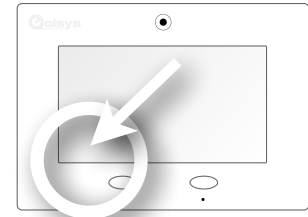

Settings



System Tests



Panel Test



Installer Code Access



Master Code Access

IQ2 DEVICES TEST



IQ2 Devices Test

Runs a connectivity test with connected remote keypads

No	Device Name	IP Address	Status	Actions
65	IQ2	.9	Active	<input type="button" value="Ping"/>

BACK

Results

Pressing “Ping” on selected device will test the connectivity between the IQ panel and the IQ2.

**Note: IQ2 devices connect to the primary panel over Wi-Fi*

FIND IT

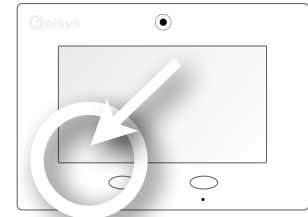

Settings



System Tests



IQ2 Devices Test



Installer Code Access



Master Code Access

CUSTOMIZATION



CUSTOMIZATION

SYSTEM SETTINGS



Use system settings to connect to Wi-Fi, adjust sound settings, turn brightness up or down, and safely eject your SD card

Setting	Description
Wireless Settings	Connect to the local network using the panel's Wi-Fi
Sound	Adjust the volume and other sound settings on the panel
Brightness	Adjust the brightness of the panel's LCD
SD Card	Display total space, available space and the option to unmount an inserted SD Card
Date & Time	Manually adjust the panel's date and time

FIND IT

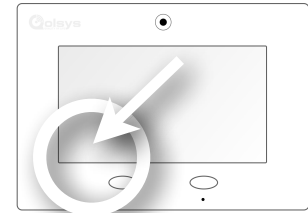

Settings



System Settings



Installer Code Access



Master Code Access

HOW TO CONNECT TO WI-FI



To connect to a Wi-Fi network, follow the steps below:



Touch “Settings” then enter installer or master code.



Touch “System Settings”



Wireless Settings

Touch “Wireless Settings”

Wi-Fi Settings

Select network

Touch “Wi-Fi Settings”

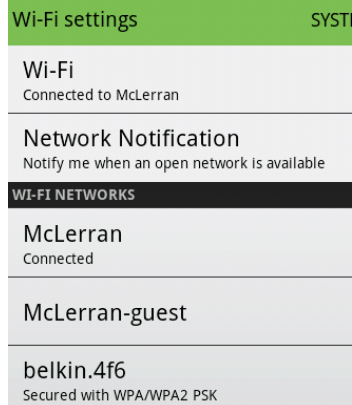

Available networks appear in a list. Touch the desired network and use the keyboard to type the password (if required)

FIND IT

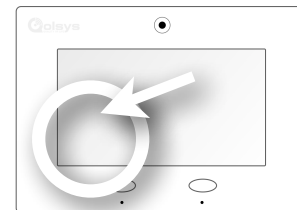

Settings



System Settings



Wireless Settings



Wireless Settings

Wi-Fi Settings

Select network



Wi-Fi Settings

Select network



Installer Code Access



Master Code Access

WEATHER



TODAY'S FORECAST

Today's forecast is displayed on the weather icon with a graphical representation of precipitation and High and Low temps.

Weather
SYSTEM READY - DISARMED
Thu - 10:52 AM

Extended Forecast

Thursday	Friday	Saturday	Sunday
Rain Showers 71°F	Rain Showers 66°F	Rain Showers 57°F	Slight Chance of Rain Showers 61°F
High 46°F	High 43°F	High 42°F	High 41°F
Low	Low	Low	Low

← BACK
? HELP
☎ CONTACT US

4-DAY FORECAST

Touch the weather icon to get a 4-day forecast. This information is updated once daily via Alarm.com services. (Will not display or update weather connected to wifi only)

LOCATION

Weather reporting is based on location as indicated by the zip code entered into Alarm.com when the account is created.

FIND IT

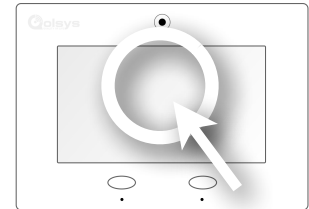

Weather

PHOTO FRAME



PHOTO FRAME

The IQ Panel can be set to display digital photos when not in use. This feature, called “Photo Frame” can be changed or turned off through “Photo Frame Settings”

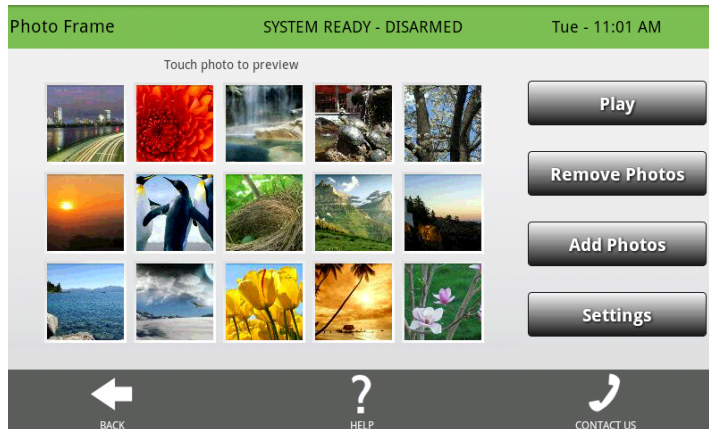

Display type

Choose a display type for your photo frame. Opt to turn it off completely, scroll through pre loaded images or view a “weather clock”

FIND IT

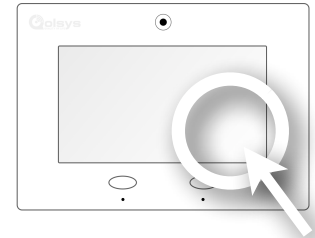

Apps



Photo Frame

PHOTO FRAME APP BUTTONS



PLAY: Starts Photo Frame immediately. Good for testing photo frame feature appearance and transitions



REMOVE PHOTOS: Allows you to remove photos one by one or all at once



ADD PHOTOS: Add new photos using an SD card or download one of several “Wi-Fi” photo sets using your panel’s WiFi connection



SETTINGS: Change the Photo Frame’s “Display Type” from Off to On or enable a “Weather Clock” screen saver. Change transitions, adjust display time, set automatic on/off times and more

FIND IT

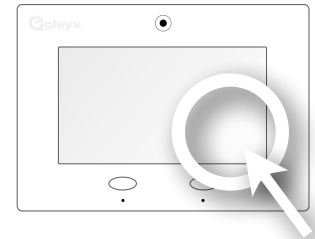

Apps



Photo Frame

LOAD IMAGES FROM SD CARD



Insert card with the label facing you



Card will slide all the way in.
To remove, push gently and card will spring out.

To load new images from an SD card:

- 1- Load photos* onto an SD Card
- 2- Insert the SD Card into the panel
- 3- Open the "Photo Frame" app
- 4- Press "Add Photos"
- 5- Choose "Replace All Photos" or "Add New Photos"

- 6- Wait for the images to load
- 7- Once loaded, you can press "Play" to test.

NOTE: Before removing the SD Card, go to "Settings" then touch "System Settings" then "SD Card" and select "Unmount"

FIND IT



SD Card Slot:
Left side of panel
behind bezel

Photo requirements:

- JPEG
- 800x480 pixels (or less)
- No larger than 1MB each
- No more than 20 images
- Saved in folder entitled "Photos"

PHOTO FRAME SETTINGS

Item	Default	Description
Duration	1 minute	How long each image will show before transitioning to the next image in the library (1, 2, or 5 minutes)
Effect	Dissolve	Transition effect used between each image (fade to black, dissolve)
Shuffle	Enabled	Display pictures in random or sequential order
Display Type	Photo Frame	Choose what to display on the screen when the panel is not in use. (Off, Photo Frame and Weather Clock)
Photo Frame Start Time	10 minutes	Choose the amount of time to wait after the last touch before starting the selected display type. (5, 10, 15, 20, 25, or 30 minutes)
Automatically turn off display	11:00 PM	Determines the time when the display shuts down completely. (use this feature to turn off the LCD at night)
Automatically turn on display	6:00 AM	Determines the time when the display "wakes up" after sleeping. (use this feature to turn the LCD back on in the morning)

FIND IT

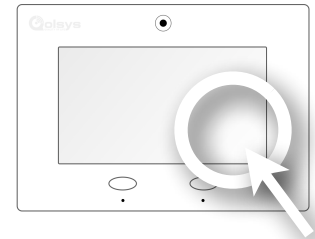

Apps



Photo Frame

DEALER CONTACT*



DEALER CONTACT

Here you can customize your contact info and determine what you'd like to be displayed in "Contact Us", located on right side of the "Home Screen" footer. Dealer Contact fields allow up to 25 characters, Tag Line 2 allows up to 50.

Dealer Contact		SYSTEM READY - DISARMED	Wed - 09:58 AM
Dealer Name	<input type="text"/>		
Tag Line 1	<input type="text"/>		
Tag Line 2	Please contact your Dealer fo		
Phone	<input type="text"/>		
Email	<input type="text"/>		
Web	<input type="text"/>	<input type="button" value="Save"/>	

 BACK

Example:

ABC Security
Automation & Security
Atlanta's Preferred
798-123-4567
jondoe@abcsecurity.com
ABCSecurity.com

FIND IT

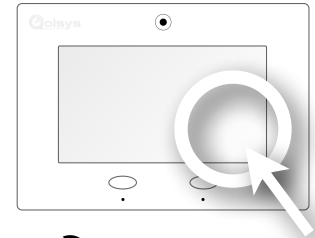

Settings



DealerContact

* Additional option available only through the Dealer Code.

CUSTOM NAMES

When pairing a sensor or device for the first time, or going back and editing them later, you can create custom names for your sensors and devices that the panel will both display and “speak” during chimes, alerts, alarm events, and in your text and e-mail notifications.

1. When choosing a name for your sensor or device touch the “Custom Description” field

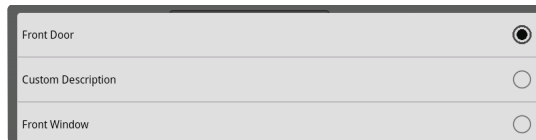

2. The Android keyboard will automatically open. Type the sensor name (24 characters max) and touch “Done”

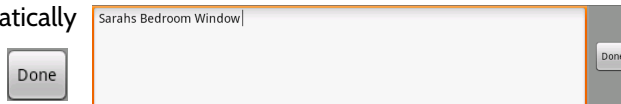

3. Touch “Save” or “Add New” to complete the process and save your changes.



FIND IT

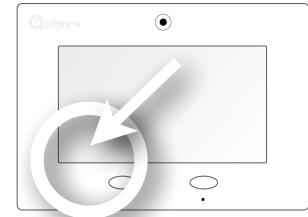

Settings



Installation



Security Sensors*



Edit Sensor

**You can also edit the names of Home Control Devices*

EDIT CHIMES

Sensors or devices paired with the IQ Panel can be assigned a unique tone or chime to help the end-user differentiate between them. For example, you may want to have a separate chime on a pool gate than you do for the front door, or assign a unique tone to the back door so you can distinguish it from the front.

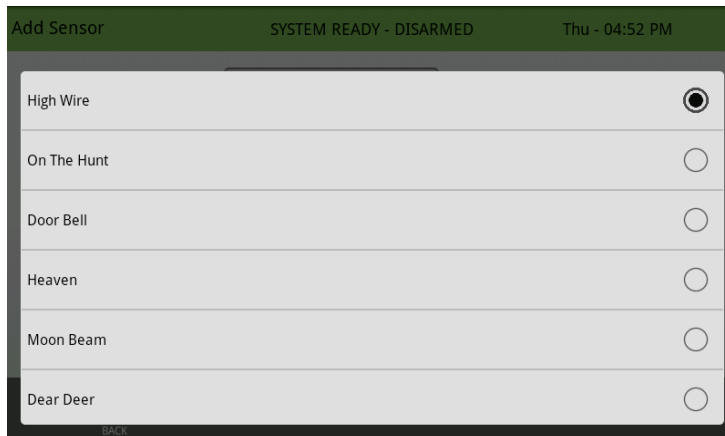

Multiple chimes are available and can be accessed from the following areas:

- Sound app
- Add sensor/device
- Edit sensor/device
- Sound settings

FIND IT

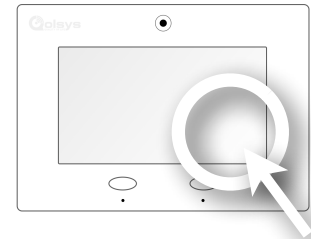

Apps



Sound

Edit Chimes

Customize sounds for individual sensors

USER MANAGEMENT



The IQ panel can hold up to 242 user codes. Only Dealers, Installers and Master users can access this app and once created you can edit all information but user type (Installer, Master, User, Guest)

User Type	Access Level	Expires
Dealer	All settings as well as Master Reset and access to change Dealer Contact information.	N/A
Installer	All Settings	N/A
Master	All user-related features and settings, including connecting to Wi-Fi, User Management, Camera App and Sensor customization	On the date indicated when created (optional)
User	Arming/Disarming, Home Control, Weather, and the Camera App	On the date indicated when created (optional)
Guest	Arming/disarming, Home Control, Weather	On the date indicated when created (optional)
Duress	Disarming (but sends duress signal to security provider) This user will be disabled unless you turn on "Duress Authentication" under "Security and Arming"	N/A

FIND IT

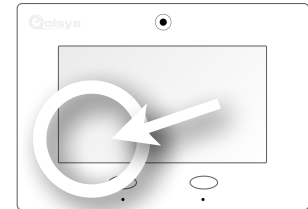

Settings



User Management



Installer Code Access



Master Code Access

LOAD HELP VIDEOS



You can customize the IQ Panel with your own help videos using an SD Card.

Note: Videos must have a resolution of 800x480, in MP4 format with a bitrate under 2000 each. All videos combined must be less than 200MB

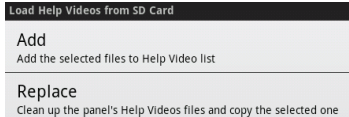

1- Select whether you want to add videos onto your panel (adding them to other available videos) or replace all existing videos with new ones.



2- Choose the videos you want to put on the panel by checking the boxes next to the video name



3- Click "OK" to continue. Once complete, the video will appear in your video library

FIND IT

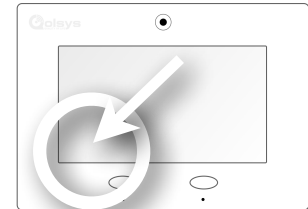

Settings



Load Help Videos



Installer Code Access



Master Code Access

TROUBLESHOOTING

ABOUT

Item	Description
Battery Status	Displays whether the battery is disconnected, charging, or full
Battery level	Displays the battery's charged percentage.
Battery voltage	Displays the battery's voltage in numbers.
Software version	Displays the panels current software version for both the user interface and the alarm.com integration
Linux Version	Displays installed Linux version.
Android version	Displays installed Android version.
Android System Version	Shows which version of the Android system the panel has currently installed
Hardware version	Displays the panel's hardware version.
Manufacturer	Displays Panel Manufacturer. (Qolsys)
System PIC Version	Displays the panel's PIC version

FIND IT

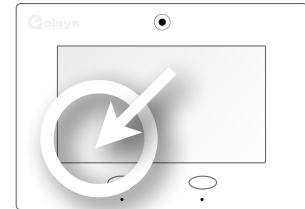

Settings



About



Installer Code Access



Master Code Access

ABOUT

Item	Description
PCA Serial Number	Shows the panel's PCA serial number
ICCI ID	Displays the panel's ICCI ID number
System Part Number	Displays the Golsys part number for the device
System Serial Number	Displays the system's serial number
RF PIC Version	Displays the system's RF PIC version
EEPROM Format Version	Displays the system's EEPROM format version
Patch Description	Shows all applied software patches, when they were installed and the status of each. Also shows next check-in time for Auto Upgrade if the Automatic Upgrade option is checked.
Last Upgrade Date	Shows the date and time of the last software update
MAC Address	Displays the panel's individual MAC address

FIND IT

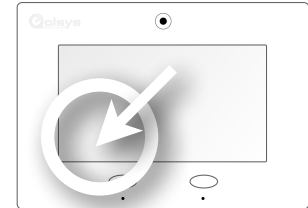

Settings



About



Installer Code Access



Master Code Access

ABOUT

Item	Description
IP Address	Displays the panel's IP Address on your local network (if connected to Wi-Fi)
Panel Up Time	Displays how long the panel has been on since the last reboot
Cellular Signal Strength	Displays the current cellular signal strength in "external" (bars out of 6) and "internal" (bars out of 31) signal strength.
Cellular Connection	Displays the connection status with alarm.com . (no signal, registered, etc.)
IMEI/MEID	Displays the system's IMEI/MEID. The last 10 digits is the Alarm.com radio serial number
Home ID	Displays the Z-Wave radio ID#
Z-Wave Firmware Version	Version of firmware installed in Z-Wave radio

FIND IT

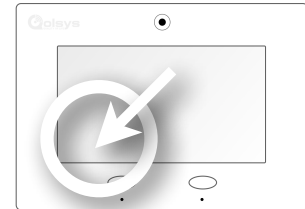

Settings



About



Installer Code Access



Master Code Access

UPGRADE SOFTWARE USING WI-FI

Keeping your panel up to date is essential in ensuring it receives the newest features and is free from bugs.

To perform a software update using Wi-Fi follow the steps below:

- 1- Ensure your panel is connected to Wi-Fi
- 2- Touch "Settings" (enter your installer code, default is 1111)
- 3- Touch "Installation"
- 4- Touch "Upgrade Software"
- 5- Touch "Upgrade Using Network" The IQ Panel will check for the latest software update. If your panel is up to date you will see a message confirming that you have the most recent software version.
- 6- If a software update IS available the panel will automatically begin downloading it.
- 7- Once the download is complete a pop up message will appear informing you that in order to install the software you must restart the panel. Touch "okay." Your panel will install the update and automatically restart.

FIND IT

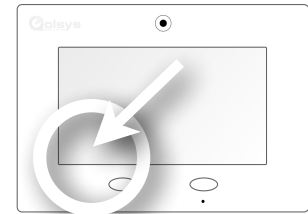

Settings



Installation



Upgrade
Software



Installer Code Access



Master Code Access

AUTOMATIC SOFTWARE UPDATES

Turning on automatic software updates enables the panel to check for new software version every 24hrs by default.

Touch “Settings”

Enter Installer code (default is 1111)

Touch “Installation”

Touch “Upgrade Software”

Make sure the “Automatic Updates” button is checked.

Change update interval by selecting “Automatic Upgrade Interval”

FIND IT

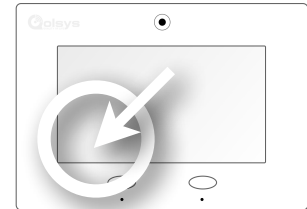

Settings



Installation



Upgrade Software



Installer Code Access



Master Code Access

SUPPORT



QUESTIONS? Contact us at techsupport@qolsys.com

SOFTWARE UPDATE VIA SD CARD

- 1- Insert an SD card into your computer. (*We recommend a class 4 or higher SDHC card with 4gb - 16gb storage space)
- 2- Download the current software from dealers.golsys.com (requires login)
- 3- Once the file is downloaded, right click the file and select "Unzip" or "Open"
- 4- Drag all files to your SD card. Delete ANY other files, and safely remove the SD card from your computer
- 5- Slide your SD card into the slot on the back left of the IQ Panel.
- 6- Touch "Settings" and enter a valid installer code (default is 1111)
- 7- Touch "Installation"
- 8- Touch "Upgrade Software"
- 9- Touch "Upgrade via SD Card"
- 10- The panel will search the SD Card for the patch and begin downloading it automatically.
- 11- Once complete touch "OK" to reboot the panel. DO NOT TOUCH THE SCREEN. The process will take about 7 minutes and the buttons may turn red, screen may turn off, etc. After the panel reboots the home screen will appear and the buttons will turn green. For the next 5 minutes the panel will update the backup partition. Do not power down or use the panel during this time
- 11- Eject the SD Card: ("Settings", enter your installer code (default is 1111), "SD Card" then "Safely Remove")

IMPORTANT: Failure to perform these steps in the proper sequence may result in data corruption and/or panel failure.

FIND IT

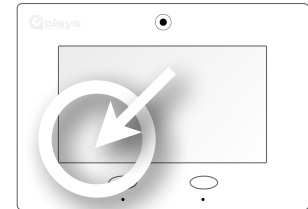

Settings



Installation



Upgrade
Software



Installer Code Access



Master Code Access

POWER DOWN

DO NOT remove all power without following the steps below. In the event of needing to move the panel from one location to another it IS safe to unplug the power supply while leaving the battery plugged in.

1. Select “Settings” from the home screen
2. Enter the installer or master code.
3. Select “Power Down”
4. Wait for panel LEDs to turn off
5. Disconnect the power

IMPORTANT: Failure to perform these steps in the proper sequence may result in data corruption and/or panel failure.

FIND IT

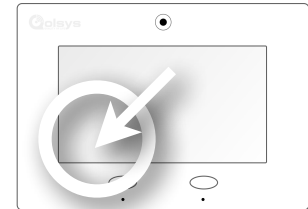

Settings



Power
Down

SUPPORT



QUESTIONS? Contact us at techsupport@qolsys.com

- Installer Code Access
- Master Code Access

PANEL REBOOT

If the panel is experiencing difficulties you can often resolve it by resetting the operating system.

Select "Settings" from the home screen

1. Enter the installer or master code.
2. Select "Panel Reboot"
3. Wait for the panel to restart

IMPORTANT: Failure to follow these steps properly may result in data corruption and/or panel failure.

SUPPORT



QUESTIONS? Contact us at techsupport@qolsys.com

FIND IT

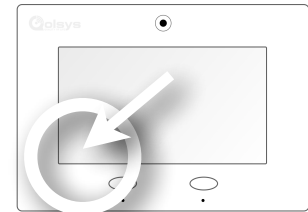

Settings



Panel Reboot



Installer Code Access



Master Code Access

HARD REBOOT

If the panel is frozen or experiencing serious difficulties and you cannot resolve it, you can force the software to reset by pressing and holding the “Home” button for 30 seconds.



x 30 sec

IMPORTANT: Performing a hard reset may result in data corruption and/or panel failure. Only use this when absolutely necessary.

FIND IT

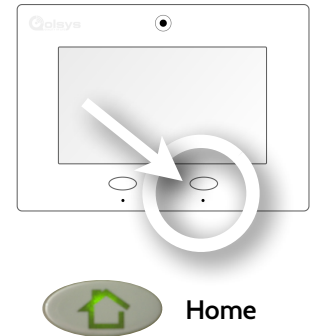

SUPPORT



QUESTIONS? Contact us at techsupport@qolsys.com

PANEL TEST TROUBLESHOOTING

FIND IT

If you run a panel test and it fails, use the following steps to fix the issue.

Test	Description	If fails:
Arm-Disarm	Tests the arm/disarm operation	Reboot panel, run test again then if necessary perform a master reset and repeat test.
Camera	Tests panel camera operation	Reboot panel, run test again then if necessary perform a master reset and repeat test.
Photos	Checks that photos are loaded in the photo frame app	<ol style="list-style-type: none"> 1) Go to Apps -> Photo Frame -> Add Photos 2) Add photos from Wifi photo sets or an SD card.
Help Videos	Checks help videos are installed in the panel.	<ol style="list-style-type: none"> 1) Go to Settings -> Load Help Videos 2) Load All the Help videos in SD card and insert it into panel 3) Add the selected files from SD card to help videos list on the panel.
Battery	Checks panel battery health	<ol style="list-style-type: none"> 1) Make sure the battery is connected. 2) If test continues to fail, replace the battery.
LCD On/Off	Checks panel's LCD screen operation.	<ol style="list-style-type: none"> 1) Reboot the panel and repeat the test. 2) If this test continues to fail, LCD may be faulty

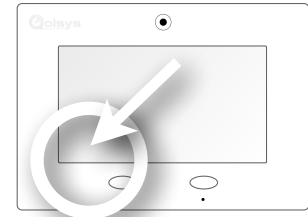

Settings



System Tests



Panel Test



Installer Code Access



Master Code Access

PANEL TEST TROUBLESHOOTING

Test	Description	If fails:
LCD Red/Green	Check panel LED operation	1) Reboot the panel and run the test again. 2) Master reset and repeat test
System Data	Check panel backup software version	1) Provide user option to create backup version on the panel. This is NEW Requirement
Panel Tamper	Check panel Tamper state	1) Check to ensure backplate is secure and installed properly.
AC Status	Check panel AC power status	1) Inspect the wire leads are secure and properly connected on the terminal block and adapter.
Internet Connection	Check panel's Internet connectivity	1) Go to Wifi Setting page, Enable Wifi and connect to a Wifi Network 2) Make sure Internet is available on the home router. You can check the Internet in System Monitor page. 3) Contact your network service provider on continued internet connectivity failure.
Support Mode	Check panel support mode (adb) is disabled	1) Contact Dealer to disable ADB from Alarm.com dealer site

FIND IT

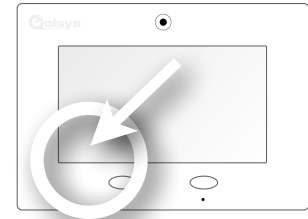

Settings



System Tests



Panel Test



Installer Code Access



Master Code Access

PANEL TEST TROUBLESHOOTING

Test	Description	If fails:
Panel Services	Checks that the panel's core services are running.	1) Reboot the panel and repeat test. 2) Master reset and repeat test
WiFi Connection	Tests whether panel is connected to Wifi network	1) Go to Wifi Setting page and enable wifi. 2) Connect to a Wifi Network
Upgrade Service	Checks that the panel's upgrade service is "pointed" to the production server.	1) Contact Dealer to enable production server from Alarm.com dealer site.
Log Service	Checks service for uploading panel's logs	1) Reboot the panel and repeat test. 2) Check wifi and Internet connectivity
Z-Wave Enable/Disable	Check panel's ZWave module operation	1) Reboot the panel and repeat test. 2) Master reset and repeat test
Sirens	Check that the panel's siren is functioning properly (Burglar, Auxiliary, Fire & CO).	1) Verify the siren is plugged in

FIND IT

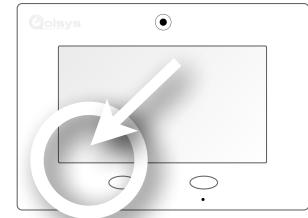

Settings



System Tests



Panel Test



Installer Code Access



Master Code Access

SYSTEM MONITOR

The system monitor allows you to see the Wi-Fi connection and information, as well as the other services running in the panel.

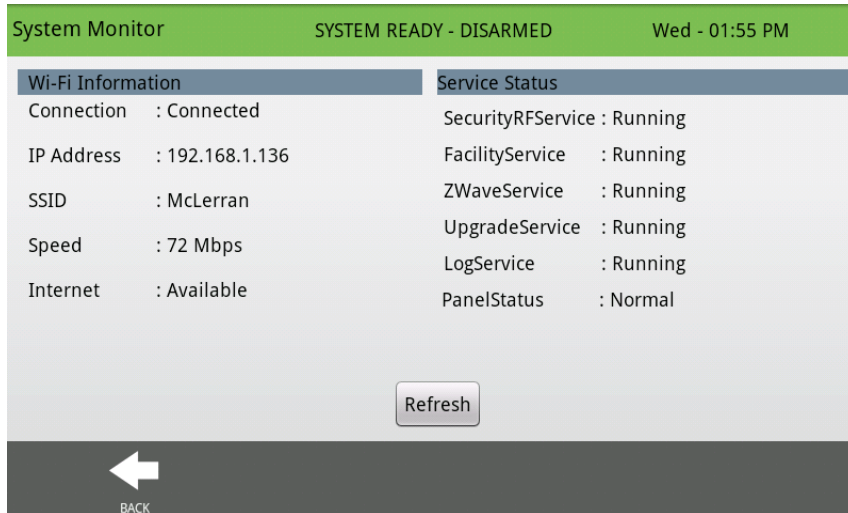

System Monitor		SYSTEM READY - DISARMED		Wed - 01:55 PM	
Wi-Fi Information		Service Status			
Connection	: Connected	SecurityRFService	: Running		
IP Address	: 192.168.1.136	FacilityService	: Running		
SSID	: McLerran	ZWaveService	: Running		
Speed	: 72 Mbps	UpgradeService	: Running		
Internet	: Available	LogService	: Running		
		PanelStatus	: Normal		

Refresh

BACK

FIND IT

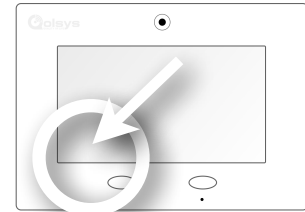

Settings



System Monitor

- Installer Code Access
- Master Code Access

CANNOT LOAD HELP VIDEOS

If your panel cannot load a help video you will receive an error message. Please ensure that your video(s) meet the requirements:

Acceptable File types:

.m4v

Total storage space:

200MB

NOTE: videos look best

in aspect ratio

800x480

FIND IT

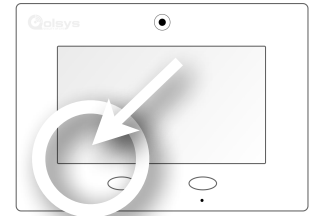

Settings



Load Help
Videos



Installer Code Access



Master Code Access

IMPORTANT

Important warning and information can be found on the interior and exterior of the panel's mounting plate.

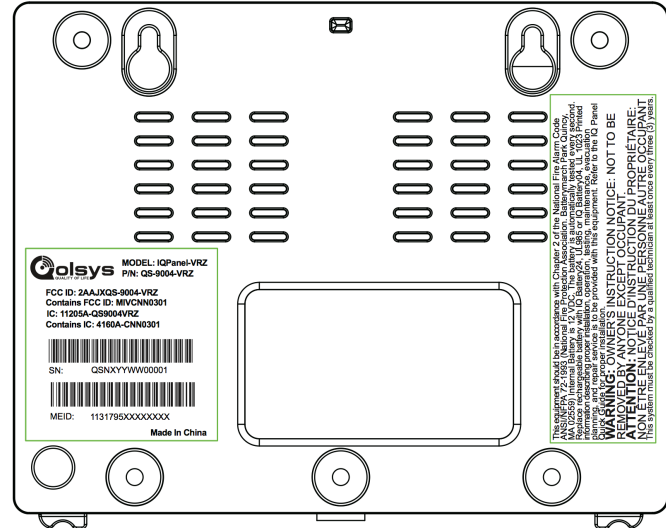
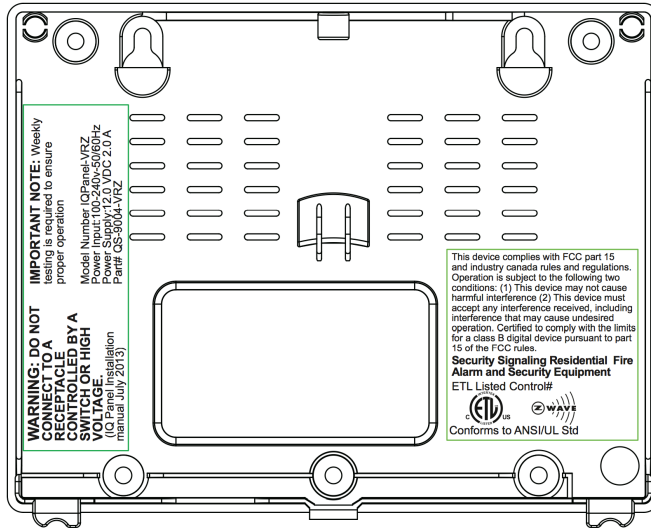

IMPORTANT

This Class [B] digital apparatus meets all requirements of the Canadian Interference–Causing Equipment Regulations.

Cet appareil numérique de la classe [B] respecte toutes les exigences du Règlement sur le matériel brouilleur du Canada.

IMPORTANT! Changes or modifications not expressly approved by Qolsys Inc. could void the user's authority to operate the equipment.

CAUTION! This equipment complies with radiation exposure limits set forth for uncontrolled environment. The antenna(s) used for this transmitters must be installed to provide a separation distance of at least 20 cm from all persons and must not be collocated or operating in conjunction with any other antenna or transmitter.

This device complies with Part 15 of the FCC Rules. Operation is subject to the following two conditions: (1) this device may not cause harmful interference, and (2) this device must accept any interference received, including interference that may cause undesired operation.

IMPORTANT

This equipment has been tested and found to comply with the limits for a Class B digital device, pursuant to part 15 of the FCC Rules. These limits are designed to provide reasonable protection against harmful interference in a residential installation. This equipment generates, uses and can radiate radio frequency energy and, if not installed and used in accordance with the instructions, may cause harmful interference to radio communications. However, there is no guarantee that interference will not occur in a particular installation. If this equipment does cause harmful interference to radio or television reception, which can be determined by turning the equipment off and on, the user is encouraged to try to correct the interference by one or more of the following measures:

- Reorient or relocate the receiving antenna.
- Increase the separation between the equipment and receiver.
- Connect the equipment into an outlet on a circuit different from that to which the receiver is connected.
- Consult the dealer or an experienced radio/TV technician for help.

SPECIFICATIONS



Items	Parameters	IQ Panel
Platform	Android OS	Android 2.2.2
LCD Display	Size	7 inch LCD
	Resolution	800x480
	Brightness	320 cd/m2
	RGB	24bit
Touchscreen	Type	Resistive, single touch
User Codes	Up to 242	Role-based (Dealer, Installer, Master, User, Guest, Duress)
Wireless	WiFi	WiFi 802.11b/g/n, 2.4Ghz,1x1
	Zigbee	Proprietary Image Sensor capable of pairing with up to 5 devices
	Z-Wave	69 total, (Up to 30 lights, 18 Smart Sockets, 6 locks, 5 thermostats and 10 other devices)
	Cellular	Verizon CDMA 1xRTT (700Mhz) or AT&T HSPA
	Security R/F	319.5 MHz, up to 59 security zones
Hardwire Input	Wired x2	Non-powered, closed loop circuit
Siren Output	Wired x1	Powered, external siren 6-12v DC 120 mA
Flash Memory	Internal Storage	4GB NAND Flash
SD Card Slot	Push-Push	Standard size x 1, Recommended card SDHC 4-16GB capacity
LED Indicator	Status LED	2 color LED indicator (green= ready, red= armed)
Speaker	Stereo 1.5W x 2	Left speaker dedicated to panel sounds and voices
		Right speaker dedicated to 2-way voice

SPECIFICATIONS



Items	Parameters	IQ Panel
Camera	Front Camera	0.3MP, Fixed Focus
Microphone	Microphone	Embedded omni-directional microphone + high gain for 2-way voice
Siren	Piezo	Built-in SIA-Rated siren with sound pressure level at 91 dba at 3.05m (conforms to UL 1023)
Tamper	Tamper Switch	Panel tamper switch with spring release and reporting to status app
Battery	Type	Lithium ion, 2500mAh capacity
Buttons	Hard Buttons	Emergency panic, Home
Mechanical	Dimension	8.5x6.5x1.5inch (LxWxH)
	Weight	1.84 lbs (.84 kg)
Power Supply	DC	12V DC Adapter; Power input: 100-240 V-50/60Hz; 2000 mA
Mount	Back Plate	Wall-mount bracket (included) or table top stand (not included)
Certification	ETL	40008507
	FCC	2AAJXQS9004VRZ
	IC	1120A-QS-9004-VRZ
	Safety	UL-985, UL-1023, UL-1635, UL-639, UL-498A, UL-634, ULC-634, ULC-S306, CSA-C22.2
Temperature	Operational	-10 to 50 C
	Storage	-40 to 80C
Camera	Front Camera	0.3MP, Fixed Focus



Document#: IQPANEL-IM-06-15

Revision Date: 06/02/15

Software version: 1.4.3

Content in this document applies to Qolsys part #s:

QS-9004-VRZ (Verizon CDMA)

QS9014-840-00-00 (Verizon CDMA)

QS9014-840-00-02 (AT&T HSPA)

QS9014-124-00-04 (Rogers HSPA)

QS9014-484-00-06 (Telefonica HSPA)

Conforms to UL Std. S985, 1023. & 1635

Certified to ULC Sub C1023 & ULC Std S545

Qolsys Inc. proprietary.

Reproduction without permission is not permitted.

