

Go!Control Panel Installation & Programming Guide



Firmware Version 1.12
ENGLISH

WIRELESS SECURITY SYSTEM

THIS PAGE INTENTIONALLY LEFT BLANK

CONTENTS

Introduction	5
About this Guide	5
About the 2GIG Go!Control System	5
Important Information	5
Installing the System in Residential Settings	5
Installing the System in Commercial Settings	5
System Features	6
Optional Features and Accessories	7
System Configuration	8
Control Panel Features	9
External Features	9
Internal Features	10
Installation Outline	11
Wireless Installation Tips	12
Sensors and Accessories	13
Wireless System Sensors	13
System Accessories	13
Installation	14
Control Panel Mounting Plate	14
Wireless Sensors	15
Hardwire Loops	15
Wiring	15
Remote Alarm Sounder	15
Solid State Output	16
Optional 2GIG Go!Control POTS Module	16
GSM (Cellular) Radio Module	18
Control Panel Wiring	19
Control Panel Wiring	20
Terminal Block Wiring Diagram	20
Backup Battery Connection and Power Supply Wiring	20
Wire Size and Length	21
Control Panel and Power Supply Mounting	22
Commercial Installations	23
NFPA Standard 72	24
Main Display Screens	25
Home Screen	25
Security Screen	25
Arming Screen	25
Menu Screen	25
System Status Screen	26
Toolbox and Installer Toolbox	27
Toolbox Screens	27
Accessing the Toolbox	27
Installer Toolbox Screens	27
Accessing the Installer Toolbox	27
Accessing the System Configuration for System and Sensor Programming	28
System Configuration Screens	28
System Status Icons	29
AC Power On/OFF	29
Phone Line Failure	29
Sounder Disabled	29
Low Backup Battery	29
Test Mode	29
Touch Screen Keypad Traffic	29
Cell Radio	29
Interior sensor open	29
Programming Navigation	30
Navigation Arrows & Go To Button	30
Questions without Sub-Options	30
Questions with Sub-Options	30
Questions with Data Entry	31
Additional buttons	31
Programming Outline	32
ANSI/SIA CP-01 Compliance	32
Programming Question Table	33
Sensor Types (Zones)	36
Voice Descriptors	38
Equipment Codes	40
Installer Programming	41
Account Registration	41
Wireless (RF) Sensor Programming	41
Q1: RF Sensor Programming Outline	41
Summary of RF Sensor # Screen	42
RF Sensor Programming Questions	42
Q1: Select RF Sensor # (01-48)	42

Wired Sensor Programming	45
Q2: Wired Sensor Programming Outline	45
Summary of Wired Sensor # Screen	46
Wired Sensor Programming Questions	46
Q2: Select Wired Sensor # (1-2)	46
Q: Select Wired Sensor# Dialer Delay (0 to 1)	47
Q: Construct Wired Sensor # Voice Descriptor	47
Q: Select Wired Sensor# Reports (0 to 1)	47
Q: Select Wired Sensor# Chime (00 to 13)	47
Wireless (RF) Key Fob Programming	48
Key Fob Programming Outline	48
Summary of RF Key Fob # Screen	49
RF Key Fob Programming Questions	49
Q3: Select Fob # (1 to 8)	49
Q: Select Fob # Used (0 to 1)	49
Q: Select Key Fob # Equipment Code (0-9999)	49
Q: Enter Key Fob # Other Equipment Code (0-9999)	49
Q: Enter Fob # Serial Number(7 Digits)	49
Q: Select Fob # Equipment Age (0 to 1)	49
Q: Select Fob # Emergency Key (0 to 4)	49
Q: Select Fob# Key # Can Disarm (0 to 1)	49
Q: Construct Fob# Voice Descriptor	49
Q: Select Fob (#) Arm No Delay (0 to 1)	50
Q: Select Fob# Key 4 Output (0-2)	50
Wireless (RF) Keypad Programming	51
RF Keypad Programming Outline	51
Summary of RF Keypad Screen	52
RF Keypad Programming Questions	52
Q4: Select RF Keypad # (1 to 4)	52
Control Panel Programming	54
Programming Questions	54
Q1: RF Sensor Programming	54
Q2: Wired Sensor Programming	54
Q3: RF Key Fob Programming	54
Q4: RF Keypad Programming	54
Q5: Exit Delay, in Seconds (45-120)	54
Q6: Entry Delay 1, in Seconds (30-240)	54
Q7: Entry Delay 2, in Seconds (30-240)	54
Q8: Dialer (0-1)	54
Q9: Dialing Prefix (0-4 Digits)	54
Q10: Call Waiting Disable Code (0-6 Digits)	54
Q11: CS #1 Phone Number (0-25 Digits)	55
Q12: CS #1 Account Number (4 Digits)	55
Q13: 2-Way Voice (0-2)	55
Q14: Silent Panic/Burglary Listen Only	55
Q15: Dialing Type (0-1)	55
Q16: Police Emergency Key (0-2)	55
Q17: Fire Emergency Key (0-1)	55
Q18: Emergency Key (0-1)	56
Q19: Quick Arming (0-1)	56
Q20: Swinger Shutdown Count (1-6)	56
Q21: Siren Supervision Time (0-3)	56
Q22: CS Lack of Usage Notification Time (0-255)	56
Q23: Radio Modem Network Failure Time (0-255)	56
Q24: Radio Modem Network Failure Causes Trouble (0-1)	56
Q25: Radio Modem Network Failure Reports (0-1)	56
Q26: Auto Stay (0-1)	57
Q27: Exit Delay Restart (0-1)	57
Q28: Quick Exit (0-1)	57
Q29: Periodic Test, in Days (0-255)	57
Q31: Cancel Time, in Minutes (5-255)	57
Q32: Cancel Display (0-1)	57
Q33: Cross Sensor 47-48 (0-1)	57
Q34: Cross Sensor Timeout, in Seconds (10-120)	58
Q35: Abort Window Dialer Delay (0-2)	58
Q36: Burglary Bell Cutoff (0 to 4)	58
Q37: Fire Bell Cutoff (0-4)	58
Q38: Time to Detect AC Loss, in Minutes (0-30)	58
Q39: Random AC Loss Report Time (0-1)	59
Q40: CS #2 Phone Number (0-25 digits)	59
Q41: CS #2 Account Number (4 Digits)	59
Q42: Remote Control Phone (0-3)	59
Q43: Installer Code (4 Digits)	60
Q44: Lock Installer Programming (0-2)	60
Q45: Lock Default Programming (0-2)	60
Q46: Trouble Doesn't Sound at Night (0-1)	60
Q47: Trouble Resound After Hold Off (0-7)	60
Q48: Download CSID (6 Digits)	61
Q49: Programming Mode Entry Reports to CS (0-1)	61
Q50: Trouble Reports to CS (0-1)	61

Q51: Manual Bypass Reports to CS (0-1)	61
Q52: AC Loss Reports to CS (0-1)	61
Q53: System Low Battery Reports to CS (0-1)	61
Q54: RF Low Battery Reports to CS (0-1)	61
Q55: Opening Reports to CS (0-1)	61
Q56: Closing Reports to CS (0-1)	61
Q57: Alarm Restore Reports to CS (0-1)	62
Q58: Trouble Restore Reports to CS (0-1)	62
Q59: Bypass Restore Reports to CS (0-1)	62
Q60: AC Restore Reports to CS (0-1)	62
Q61: System Low Battery Restore Reports to CS (0-1)	62
Q62: RF Low Battery Restore Reports to CS (0-1)	62
Q63: Phone Fail Detect (0-1)	62
Q64: Smart Test Reports	62
Q65: RF Jam Causes Trouble (0-1)	63
Q66: Daylight Saving (0-1)	63
Q67: Daylight Saving Start Month (01-12)	63
Q68: Daylight Saving Start Monday (1-7)	63
Q69: Daylight Saving End Month (01-12)	63
Q70: Daylight Saving End Sunday (1-7)	63
Q71: System Tamper Causes Trouble (0-1)	63
Q72: Quick Bypass (0-1)	63
Q73: Disarming Keyfob After Alarm (Alert) (0-1)	63
Q74: Keyfob Arm/Disarm Confirmation (0-1)	63
Q75: Auto Un Bypass for Manual Bypass (0-1)	64
Q76: Force Bypass Reports (0-1)	64
Q77: Event Log (0-3)	64
Q78: Output	64
Q79: Z-Wave Feature (0-3)	64
Q80: Z-Wave Switches Feature (0 to 1)	64
Q81: Z-Wave Thermostats Feature (0 to 1)	64
Q82: Z-Wave Door Locks Feature (0-1)	65
Q83: Select Temperature Display Units (0-1)	65
Q84: Services Require Master Code (0 to 1)	65
Q85: Master User Access to Z-Wave Toolbox (0-1)	65
Q86: Disable Siren After Two-Way Audio (0-1)	65
Q87: Keyfob/Remote Arming Mode on System Not Ready (0-2)	65
Q88: Siren Mode (0-1)	65
Q89: Allow Backlight Always On (Demo Mode) (0-1)	65
Q90: Energy Feature (0 to 1)	66
Q91: Radio Modem Supplier	66
Q92: Network Device (0 to 1)	66
Q: Port # (1 to 8)	66
Q: Used (0 to 1)	66
Q: Port Value (0 to 65535)	66
Q: Port Forward IP Address	66
Q93: Enter Broadband Network Failure Time (1-255)	66
Q94: Select Broadband Network Failure Causes Trouble (0 to 1)	66
Q95: Select Broadband Network Failure Reports (0 to 1)	66
Final Installation Setup	67
Exiting Programming (System Configuration)	67
Customizing the Installation	67
Installer Testing	68
Access the Installer Toolbox	68
Disable/Enable Status	68
Disable the Sounder	68
Enable the Sounder	68
Sensor Type (Zone) Report Test	68
Walk Test	68
Signal Strength Indicators	68
Performing a Walk Test	69
Radio Status Test	69
Cell Phone Test	69
Telephone Test	70
Restore Default System Configuration	70
Soft Reset	70
Hard Reset	70
Regulatory Information	71
Wireless Product Notice	71
FCC Notice	71
FCC Telephone Rules and Regulations	71
Industry Canada Notices	71
Commercial Regulatory Listings	71
Limited Warranty	73

THIS PAGE INTENTIONALLY LEFT BLANK

INTRODUCTION

ABOUT THIS GUIDE

This guide provides distributors, dealers, and authorized installation personnel with information about installing, testing, and maintaining the 2GIG Go!Control system. 2GIG by Linear products are not sold directly to consumers and can only be obtained from authorized distribution channels. For a list of authorized distributors, visit: <http://www.2gig.com/find-a-distributor>.

ABOUT THE 2GIG GO!CONTROL SYSTEM

Depending on the options set during the installation, the 2GIG Go!Control system has the ability to provide three forms of protection: burglary, fire, and emergency. The system consists of the 2GIG Control Panel, wireless sensors for perimeter and interior burglary protection, and wireless smoke and carbon monoxide detectors. In addition, optional remote control key fobs, wireless panic buttons, and keypads may also be installed.

The system monitors all protection sensor types (a.k.a., “zones”) and the system’s status. The Control Panel displays monitoring information and controls the alarm siren. The system can also be setup to send alarm and status reports to a Central Station and has the capability for two (2)-way voice communications with the Remote Service Provider (RSP).

When a security system is installed, insurers may offer discounts on the homeowners’ or renters’ insurance policy. Although the requirements and discount credits vary for each different insurer, users can generally save money as the level of protection increases. It is recommended that you inform the end user to check with their insurance agent to determine if the insurer has specific requirements and/or offers any discount(s).

IMPORTANT INFORMATION

The 2GIG Go!Control security system conforms to the Security Industry Alarm Coalition’s *ANSI/SIA CP-01: Control Panel Standard-Features for False Alarm Reduction*. It also meets the residential security system certification criteria for the ETL Listed Mark.

The recommended storage temperature for all Control Panels is -10°C to 60°C (14°F to 140°F). For optimal Control Panel use, operation temperature is 0°C to 49°C (32°F to 120°F). No altitude range limitations have been reported while transporting Control Panel.

Installing the System in Residential Settings

When installing the system in a residential setting, be aware of the following:

- **Fire warning systems must be installed in accordance with national codes.** In the United States, fire warning systems must be installed in accordance with *ANSI/NFPA 72 National Fire Alarm and Signaling Code* and *ANSI/NFPA 70 National Electric Code*.
- **A permit may be required for this alarm system.** Some cities and municipalities may require an alarm system permit. Before installing this system, always ensure that you are in compliance with any national, regional, and local laws, rules, and/or guidelines.
- **This system is intended for use with approved-model smoke alarms only.** For use as a smoke alarm system, there must be at least one (1) smoke alarm programmed into the Control Panel and must use only approved model smoke alarms. Visit the 2GIG Dealer Web Site at dealer.2gig.com.
- **Failure to follow ETL requirements voids this system’s ETL Listed mark.** Failure to install the Control Panel and accessories in accordance with the ETL requirements documented in this manual voids its ETL Listed Mark.





Installing the System in Commercial Settings

When installing the system in a commercial setting, be aware of the following:

- **The system cannot be used for fire protection in commercial settings.** In a commercial setting, it is important to know that the Control Panel is neither designed nor intended for use as a fire protection system.
- **The system is intended only for security protection of premises.** In a commercial setting, this system is only intended for protection of commercial premises, such as a mercantile or office. It is neither designed nor intended to protect commercial bank vaults.
- **A permit may be required for this alarm.** Some cities and municipalities may require an alarm system permit. Before installing this system, always ensure that you are in compliance with any national, regional, and local laws, rules, and/or guidelines.

SYSTEM FEATURES

The 2GIG Go!Control system offers security protection for your property, 24-hour emergency monitoring, and can optionally be used for fire detection in the home. Features include:

- **Full Voice Response.** The panel gives clear notifications that indicate system status, zone descriptions, alarms, and emergencies.
- **Date, Time, and Weather Display.*** Scroll through the date, time, and daily weather forecast. Provides the ability to receive messages, including severe weather warnings.
- **Quick Access.** The one touch access buttons allow the quickest help possible in an emergency. The front panel  and  buttons serve as controls as well as indicators. Pressing the  button displays emergency icons on the display for Panic, Fire, and Emergency alarm activation (each has programmable options and can be enabled or disabled). Pressing the  button changes the system display to the Home screen
- **Full Color Touch Screen.** Control all system functions with an easy-to-use color touch screen puts a wide range of security and home automation controls at your fingertips.
- **Multiple Arming Options.** Secure your home by arming your system “AWAY” or “STAY.” The Quick Arm/Exit and Bypass features offer added convenience.
- **Home Automation Radio Module.** The built in Z-Wave radio enables various home automation functions including HVAC, appliances, lighting, and lock control.
- **Two (2)-way Response Over Cellular.*** Two-way voice lets central station operators listen in and talk to you when a signal is received, ensuring that the proper emergency response personnel will be dispatched if necessary.
- **Fully Self-Contained.** The fully self-contained panel contains a backup battery, and allows 32 user codes to monitor up to 48 wireless zones including eight (8) key fobs, four (4) keypads, It also provides two (2) hardwire loops, 15 sensor types (a.k.a., “zones), a supervised bell output, and a programmable solid-state control output.
- **Over-The-Air (OTA) Updates.*** There’s no need to worry about the panel’s software becoming outdated. With the OTA function, the panel can be remotely updated with the latest software.
- **Remote Control Options.*** Always be in control by remotely managing your system from a computer or web-enabled mobile phone (iPhone, Android, etc.).

* Feature requires the optional GSM (Cellular) Radio module and an active account with an Remote Service Provider.

Optional Features and Accessories

Optional features that can be purchased to enhance the system include:

- **2GIG GSM (Cellular) Radio Module.** An on-board digital communicator reports alarms and trouble to a Central Station receiver via the standard telephone network and a two (2)-way voice communication with the Central Station. It also supports OTA updates and remote control of the system using telephone or a Web-enabled device through the Internet.
- **2GIG 900 MHz Transceiver Module.** It sends and receives signals with wireless touch screen keypads and image sensors. Touch screen keypads allow remote control of the system through the same graphic interface design as the 2GIG Control Panel. Note that the 2GIG 900 MHz Transceiver Module, touch screen keypad, and image sensor are only available in some regions.
- **2GIG Wireless Touch Screen Keypad.** A wall-mounted, full-color, touch screen interface that provides many of the same easy-to-use keypad functions available on the Control Panel. It is designed for indoor use only and gives users the ability to control lights, thermostats, and door locks, as well as to view the status of every sensor zone. When the 2GIG 900 MHz Transceiver Module is installed in the Control Panel, the system can be programmed to communicate with up to four (4) Wireless Touch Screen Keypads.
- **2GIG Go!Control POTS Module.** The POTS (Plain Old Telephone Service) module offers the same features and the cellular module only over a land-line (instead of cellular), such as two (2)-way-voice communication with the remote monitoring service.
- **2GIG Go!Bridge IP Communicator.** The Go!Bridge provides Internet connectivity between the monitoring service's Central Station and the Go!Control® Panel (requires the 2GIG 900 MHz Transceiver Module and supports automatic firmware updates, provides interactive security services, and increases supervision using signal-forwarding to the Central Station.
- **2GIG Super Switch Takeover Module.** The takeover module communicates with the 2GIG Control Panel and is designed to convert up to eight (8) pre-wired zones to supervised wireless zones.
- **2GIG Hardwire Conversion Kit.** This kit provides installers with an easy way to convert the zones of a pre-wired security alarm system to 2GIG wireless zones. The kit includes one (1) Super Switch Takeover Module (Wireless Takeover of an Alarm System, US Patent No. 8,638,218). You can also install two (2) additional modules, which provides installers with the capability to convert up to 24 pre-wired security zones to wireless zones.

SYSTEM CONFIGURATION

This illustration details the entire system configuration (including optional features). See "Optional Features and Accessories" on page 7.12

Figure 1 Complete System Configuration

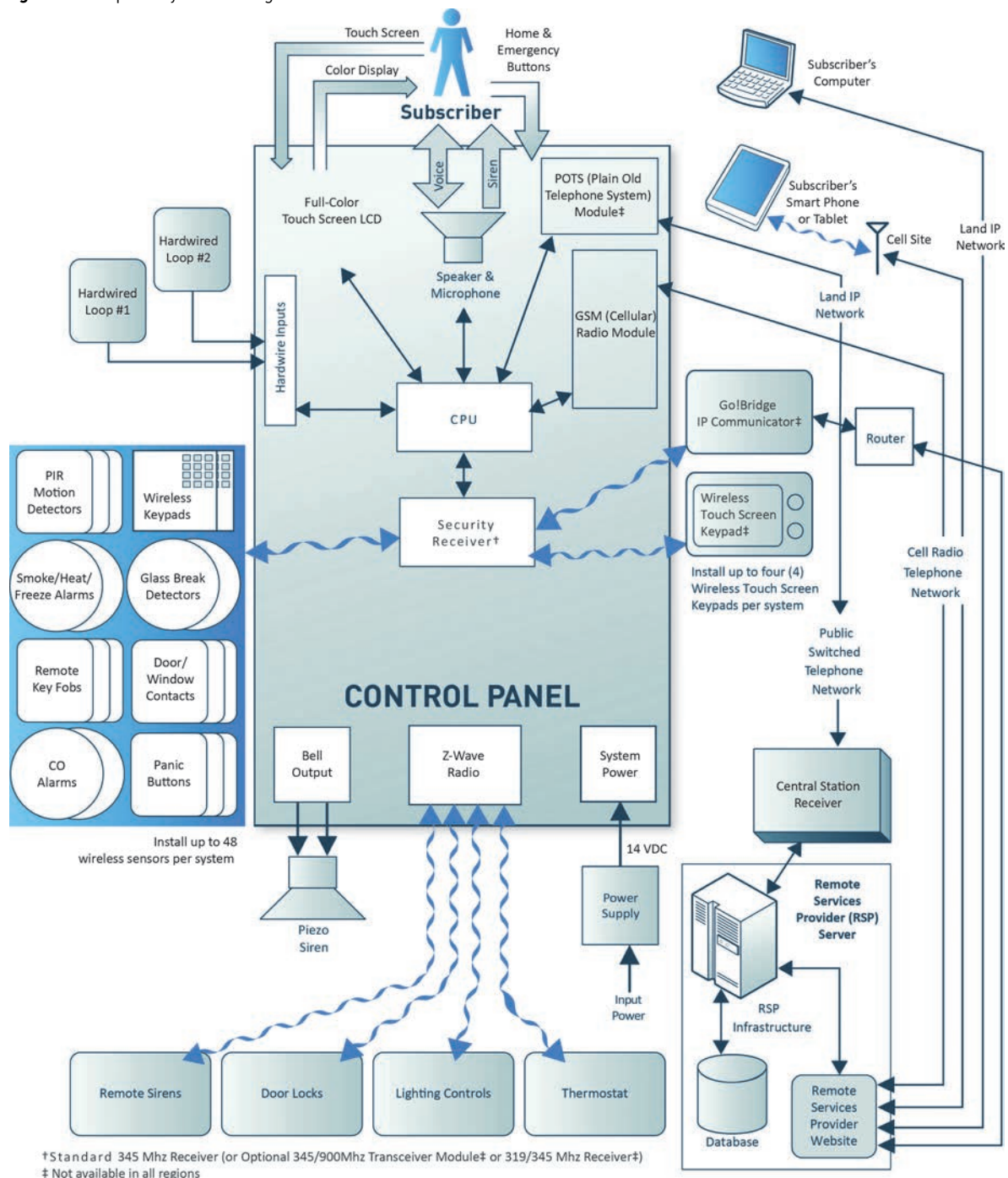

diagr-cp-entire-system-diagram-v1-12-en.jpg

CONTROL PANEL FEATURES

EXTERNAL FEATURES

Figure 2 Control Panel External Features

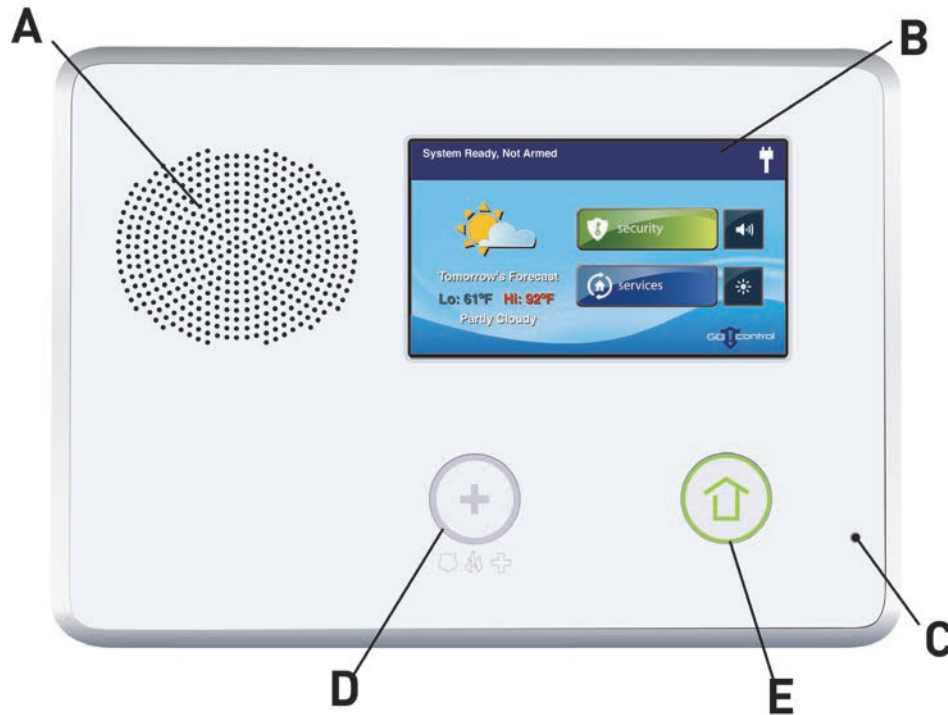

A Alarm Sounder and Speaker	Sounds all system local alarms, voice prompts, system sounds, and audio for two (2)-way voice communications with the Central Station
B Color Display with Touchscreen	Shows all system information, status, programming, and functions as the keypad. Display cycles clock, calendar, and weather with an Alarm.com account (press manually to change)
C Microphone	For voice communication with the Central Station
D Emergency Button/Indicator	Lights WHITE when enabled for emergency alarms and flashes during emergency alarms
E Home Button/Indicator	<p>Sensor Status Lights GREEN when <i>all</i> sensors are closed (ready to arm) Not lit when <i>any</i> sensor is open (not ready to arm)</p> <p>Arming Status Lights RED when system is armed Flashes RED during the Entry Delay</p> <p>Alarm Memory Flashes RED during an alarm Flashes RED after an alarm while system is still armed</p> <p>Power Outage Flashes WHITE during power outage (system on battery backup) Flashes GREEN when all sensors are closed (ready to arm) Flashes ORANGE when any sensor is open (not ready to arm) Flashes RED while system is armed</p>

INTERNAL FEATURES

Figure 3 Control Panel Internal Features

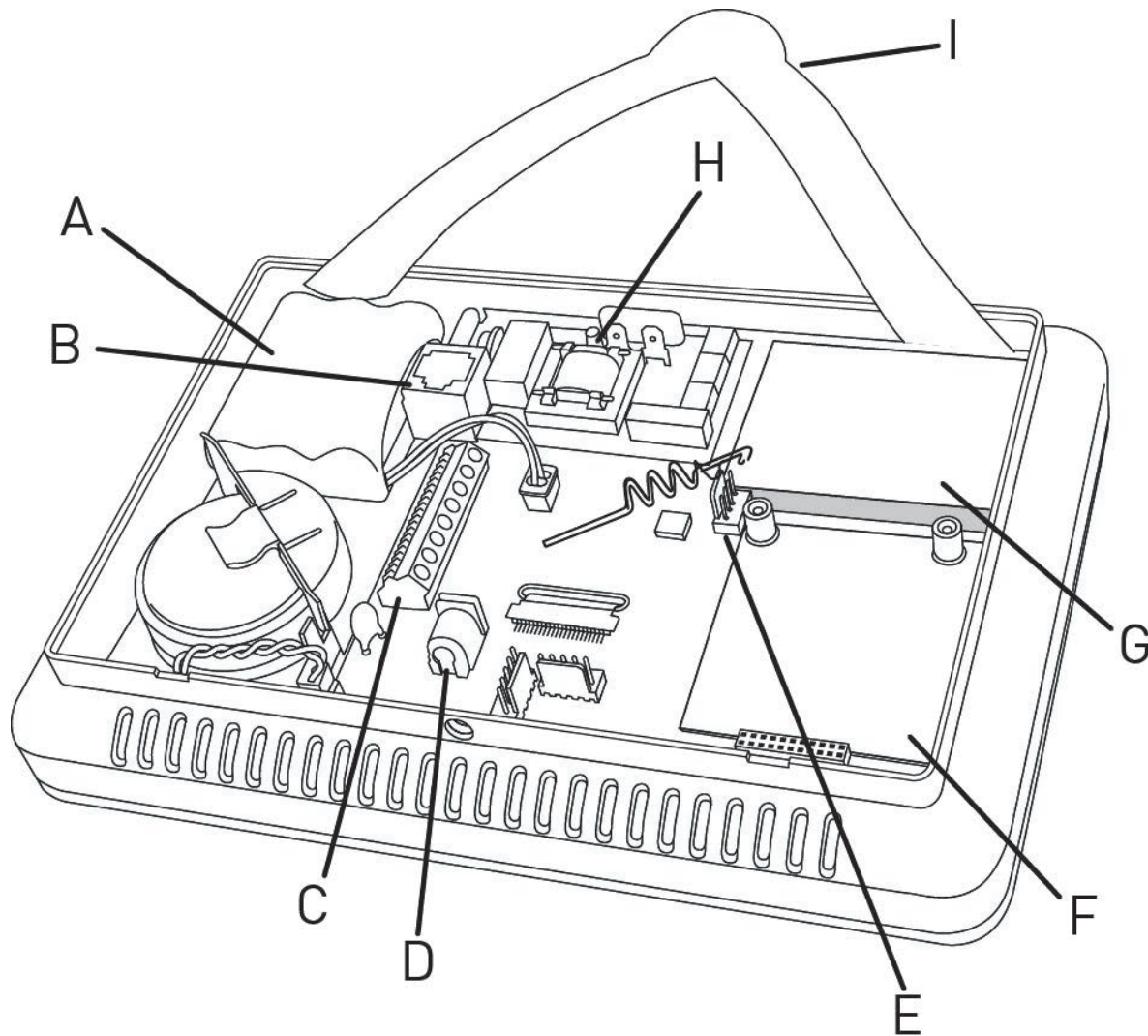

A Backup Battery Pack	The standard backup battery that is included with all 2GIG Control Panels does not support UL 985 installations. To comply with the secondary supply requirement in <i>UL 985 Household Fire Warning System Units</i> , you must install the 2GIG Console Battery Pack (2GIG-BATT2X).
B Telephone Jack	Used for RJ45 connection to installation's RJ31X telephone jack. See " <i>Optional 2GIG Go!Control POTS Module</i> " on page 16.
C Terminal Block	Connections for power, solid state output bell, and hardwire loops.
D Alternate Power Supply	Alternate connection for power. (Plug-in barrel connector)
E J4 Pin Connector	Connector for the Firmware Update Cable used to update the firmware version on the Control Panel.
F Optional Receiver Module	2GIG Go!Control POTS Module for over-the-air communication with the Central Station. . See " <i>Optional 2GIG Go!Control POTS Module</i> " on page 16.
G Main Receiver Module	Receiver for peripheral device transmissions (or an optional 2GIG 900 MHz Transceiver Module for use with the Wireless Touch Screen Keypad).
H POTS Module (Optional)	2GIG Go!Control POTS Module for connecting the lineman's phone (a.k.a., <i>buttset</i>) for monitoring the telephone line. See " <i>Optional 2GIG Go!Control POTS Module</i> " on page 16.
I Third-Hand Hanger Strap	Hooks onto mounting plate during installation to hold the Control Panel while wiring.

INSTALLATION OUTLINE

Use the following outline in conjunction with this *Installation and Programming Guide* to guide you through the installation steps.

- 1 Unpack the system and identify the system components.
 - 2 Create an *Installation Floor Plan* to determine the best centralized location for the Control Panel.
 - 3 Decide where to best install the wired and/or wireless sensors. Guidelines are available in the *Installation Instructions* included with each sensor.
 - 4 Identify an unswitched wall outlet to use for the Control Panel's power supply.
 - 5 (Optional) Install the GSM (Cellular) Radio Module in the Control Panel. See "*GSM (Cellular) Radio Module*" on page 18.
- NOTE:** (Optional) If installing the 2GIG Go!Control POTS Module, identify or install a USOC. RJ31X telephone jack to connect the module to the phone line. See "*Optional 2GIG Go!Control POTS Module*" on page 16.
- 6 Use the Control Panel's backplate to mark the drywall cutouts for the Control Panel. Then make the cutouts and attach the backplate to the wall. See "*Control Panel Mounting Plate*" on page 14.
 - 7 Install each of the system's wireless sensors. If either of the two hardwire loops are going to be used, install the contacts and route the loop wire to the Control Panel's wall cutout.
 - 8 Install the optional hardwire sounder, and route the connection wire to the Control Panel's wall cutout.
 - 9 If used, route the telephone line from the RJ31X jack to the Control Panel's wall cutout.
 - 10 Use the third-hand hanger strap to hang the Control Panel on the mounting plate. Then connect all wiring to the Control Panel's terminal block. See "*Control Panel Wiring*" on page 19 and "*Terminal Block Wiring Diagram*" on page 20. If you install the 2GIG Go!Control POTS Module, plug the telephone line into the POTS module. See "*Optional 2GIG Go!Control POTS Module*" on page 16.
 - 11 Plug the backup battery connector into the connector on the circuit board.
 - 12 Swing the Control Panel up, placing the bottom over the lip of the mounting bracket. Push the top of the Control Panel into the mounting bracket until it snaps into place, then secure it with the retaining screw.
 - 13 Plug the power supply into the unswitched wall outlet.
 - 14 Program the system as described in this manual and document any custom setup options for the end user in the space provided in the *User Guide*.
 - 15 Test the system as described "*Installer Testing*" on page 68.
 - 16 Educate the end user(s) about basic system operations and provide them with the Control Panel's *User Guide*.

WIRELESS INSTALLATION TIPS

When installing any wireless system, consider certain limitations. Low power wireless transmitter signals do NOT broadcast equally through all types of construction materials. However, the Control Panel does contain a sensitive receiver that typically allows for placement of transmitters in nearly all locations. To determine the best possible placement for wireless sensors, review the following illustration.

Figure 4 Wireless Installation Tips

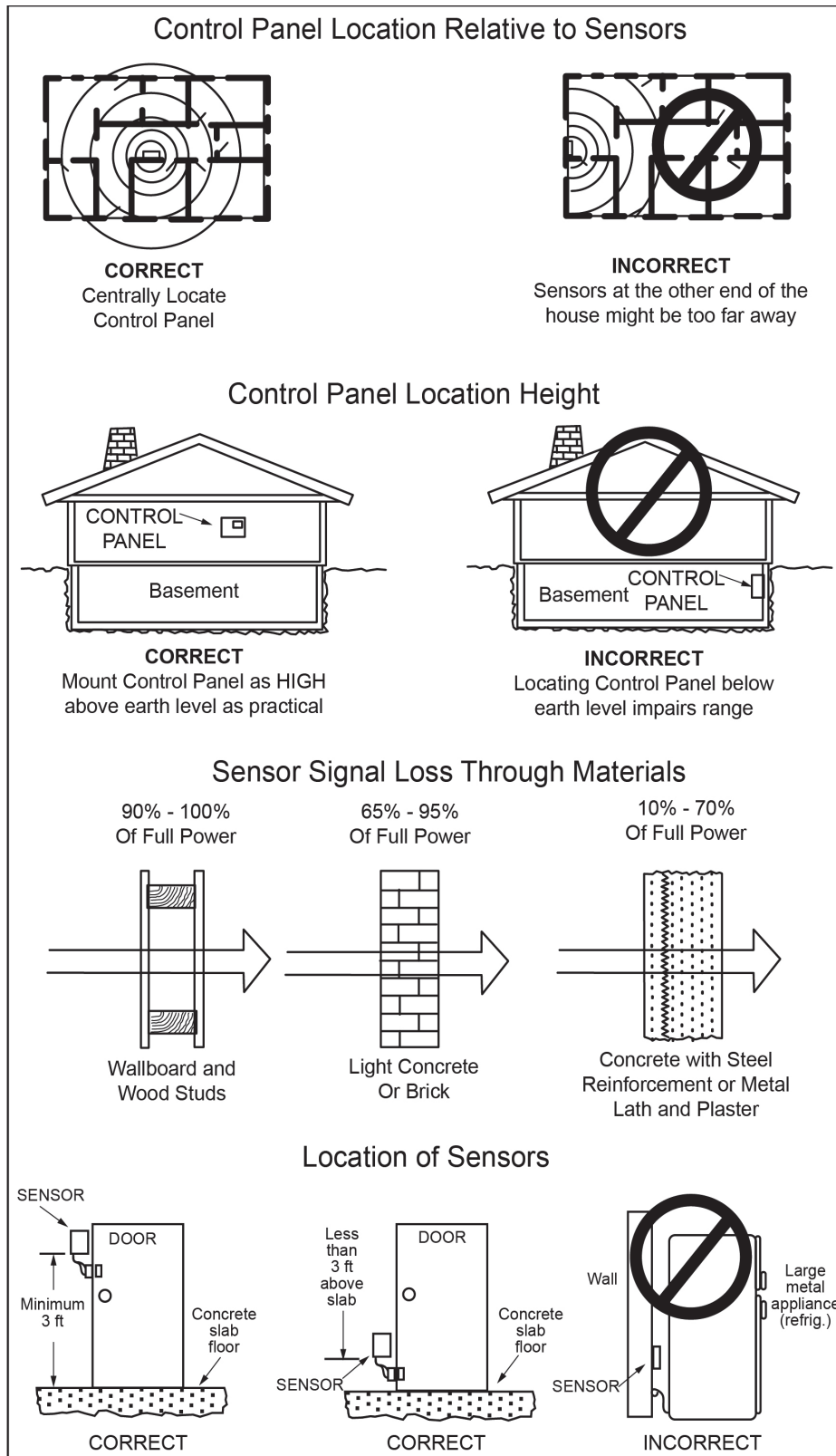

SENSORS AND ACCESSORIES

WIRELESS SYSTEM SENSORS

- Thin Door/Window Contact
- Recessed Door Contact
- Passive Infrared (PIR) Motion Detector
- Four (4)-Button Keyfob Remote
- Panic Button Remote
- Glass Break Detector
- Wireless Smoke/Heat Alarm
- Wireless Touch Screen Keypad
- Wireless Touch Screen Keypad
- Super Switch Takeover Module (*Wireless Takeover of an Alarm System, US Patent No. 8,638,218*)

SYSTEM ACCESSORIES

- GSM (Cellular) Radio Module
- Internal Antenna
- External In-Wall Antenna
- External Attic Mount Antenna
- Standard Battery Pack (UL 1023)
- Console Battery Pack (UL 985)
- Replacement Power Supply
- Go!Bridge IP Communicator
- Hardwire Conversion Kit

INSTALLATION

CONTROL PANEL MOUNTING PLATE

Mount the Control Panel on the wall in a convenient location (or use the optional desk mount). These tools may be required to mount the Control Panel onto the wall:

- Screwdriver
- Wire Stripper
- Staple Gun
- Drywall Saw (or equivalent)
- Ladder

- 1 Remove the locking screw from the top of the Control Panel case and remove the mounting plate.
- 2 Use the mounting plate as a template to mark the wall for the wiring cutout slot. Use a drywall saw to cut the slot.
- 3 If using the optional GSM (Cellular) Radio Module with an external antenna, remove the plastic knockout labeled "EXTERNAL ANTENNA" on the mounting plate. Mark and cut a slot in the drywall for the external antenna.
- 4 Attach the mounting plate to the wall using three (3) screws.

Figure 5 Control Panel Mounting Plate

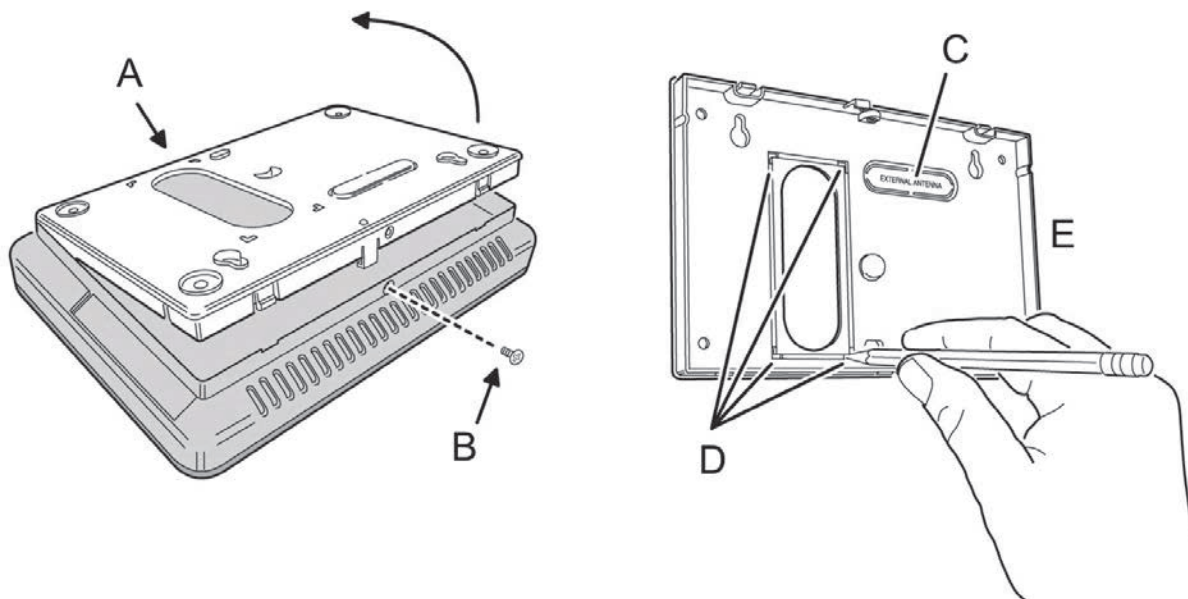

- A Mounting plate
- B Remove case screw and mounting plate
- C If using external antenna, remove knockout plate.
- D Use mounting plate as a template to mark wire cutout hole in dry wall.
- E Mount plate with three (3) screws.

WIRELESS SENSORS

Install wireless sensors in the appropriate location using the *Install Instructions* as your guide. Instructions are included with each wireless sensor.

HARDWARE LOOPS

Hardware loops can be programmed either Normally Open (N/O) or Normally Closed (N/C). End-of-Line Resistors (EOLR) can also be used to supervise the loops. Only contacts should be used with the hardware loops.

NOTE: The Control Panel does not support powering external devices (PIR's, etc.).

NOTE: Hardware loops cannot be used for a CO or Fire sensor loop.

- 1 If either of the two (2) hardware loops are going to be used, install the contacts and then route the loop wire to the Control Panel's wall cutout.
- 2 If end-of-line supervision is required for the loop, install a 2.2kΩ resistor (not supplied) as shown in *Figure 6 Hardware Loop Wiring*.

Wiring

Hardware loops need to be programmed for contact type.

Figure 6 Hardware Loop Wiring

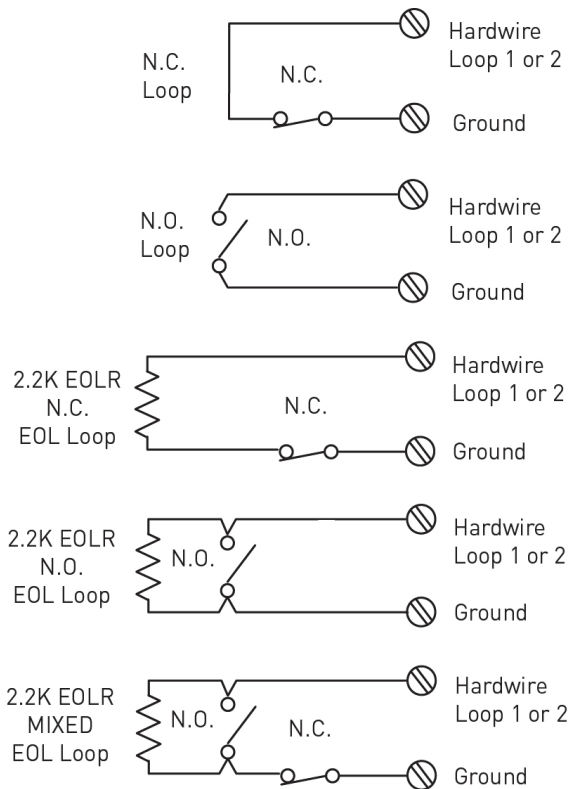

WARNING: Stranded conductors clamped under wire-binding screws or similar parts shall have the individual strands soldered together or arranged in a construction that has been determined to be the equivalent.

REMOTE ALARM SOUNDER

The Control Panel provides two (2) terminals for an optional connection to a remote electronic alarm sounder.

Figure 7 Remote Alarm Sounder

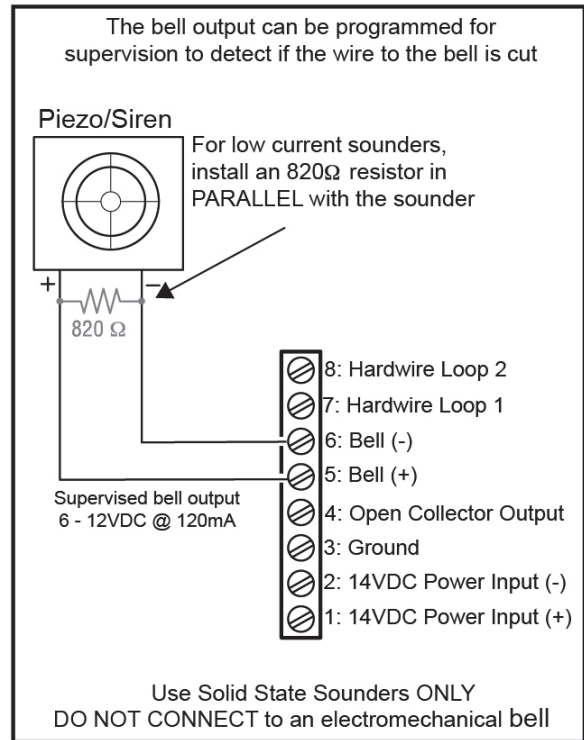

WARNING: To avoid damage to the output, do NOT connect an electromechanical bell to these terminals.

The bell terminals can be supervised. If Q21: *Siren Supervision Time* is set to (1) *Enabled*, and the wire between the Control Panel and sounder is cut, the Control Panel displays a trouble alert message for siren supervision and sends a bell trouble report to the Central Station.

- 1 Install the remote sounder in a secure location where it will be easily heard by occupants.
- 2 Route wiring from the remote sounder location to the Control Panel's wall cutout.

NOTE: If the piezo alarm siren for the remote sounder has an extremely low current draw or the sounder produces hum or noise, install an 820Ω resistor in parallel with the sounder.

SOLID STATE OUTPUT

The Control Panel provides one (1) solid state output that can be programmed to activate during various conditions. The output can switch up to 250 mA @ 16 VDC to ground.

NOTE: For ETL Listing, an external DC Backup Power Supply is required for a load connected to Terminal 4.

NOTE: When the Control Panel is connected with an AC power source, Terminal 1 provides DC Power only.

Figure 8 Solid State Output

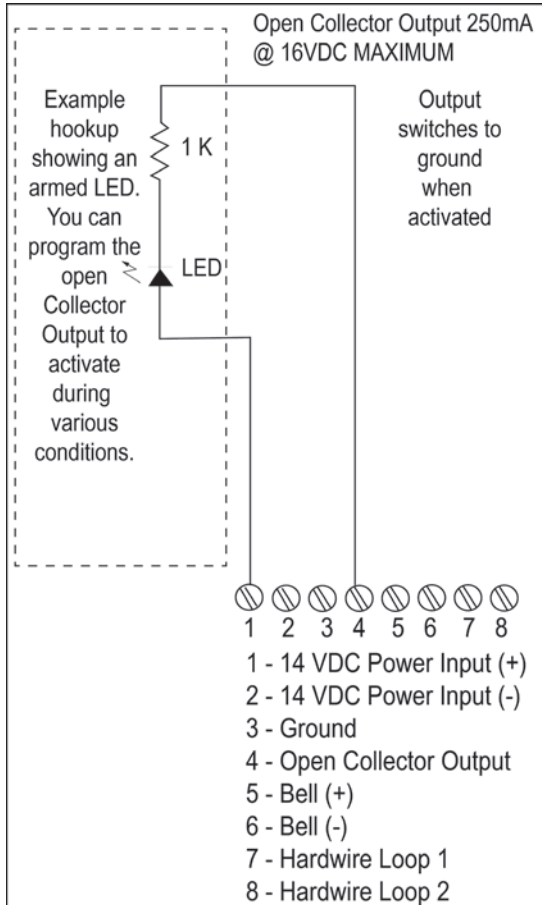

This output only functions while the Control Panel is receiving power from the wall power supply.

- 1 Install the device to be controlled by the solid state output.
- 2 Route wiring from the device location to the Control Panel's wall cutout.

WARNING: To avoid damage to the output, do NOT connect an electromechanical bell to these terminals.

OPTIONAL 2GIG GO!CONTROL POTS MODULE

To use the telephone jack, you must install the 2GIG Go!Control POTS Module. Both the incoming and outgoing telephone line can be connected.

Figure 9 2GIG Go!Control POTS Module

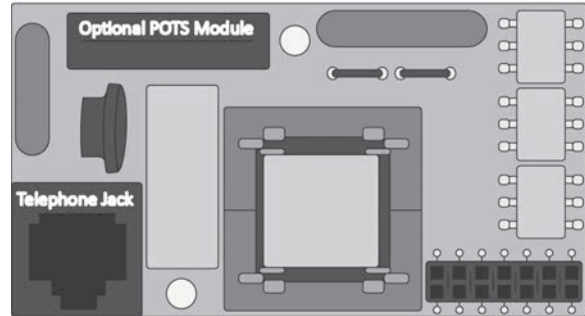

When the digital communicator activates, all local telephones are disconnected to prevent an off-hook telephone on the premises from blocking the digital communicator's call.

Figure 10 2GIG Go!Control POTS Module Installation

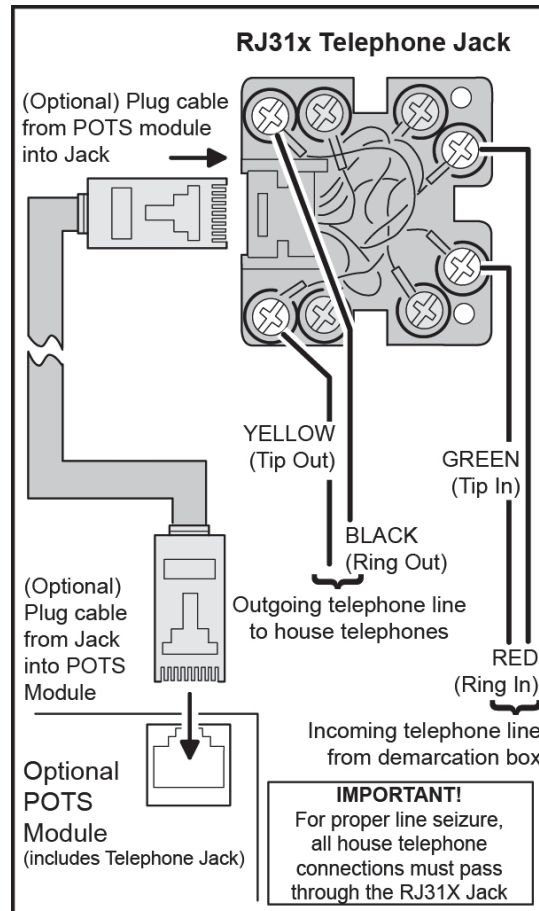

See "Wire Size and Length" on page 21 for wire size and maximum length.

- 1 Run a four (4)-conductor telephone cable from the telephone company's demarcation point to the Control Panel mounting plate.
- 2 Install the 2GIG Go!Control POTS Module into the Control Panel.

WARNING: To reduce the risk of fire, use only No. 26 AWG or larger telecommunication line cord for phone line communications.

- 3 At the demarcation point, do the following:
 - 3a Disconnect only the house telephones that are wired to the box output.
Do not disturb the telco input "drop" side of the box or any earth grounds.
 - 3b Connect the RED cable wire to the box **Ring**, and the GREEN cable wire to the box **Tip**.
 - 3c Connect the BLACK cable wire to the house telephone **Ring** wire(s), and the YELLOW cable wire to the house telephone **Tip** wire(s).
- 4 At the Control Panel, do the following:
 - 4a Connect the cable's RED wire to the RJ31X jack's **Ring in** terminal, and the GREEN wire to the RJ31Xjack's **Tip in** terminal.
 - 4b Connect the cable's BLACK wire to the RJ31X jack's **Ring out** terminal, and the YELLOW wire to the RJ31Xjack's **Tip out** terminal.
 - 4c Snap the cover on the jack.
 - 4d Plug one end of the modular cable into the jack and slide it through the hole in the mounting plate into the wall.
- 5 Power ON the Control Panel.
- 6 Access the System Configuration screen as follows:
 - 6a At the **Home** screen, tap the system logo in the lower-right corner.
 - 6b At the **Enter Your Code** screen, enter the *master installer code* (the default code is 1561).
 - 6c At the **Installer Toolbox** screen, press **System Configuration**.
 - 6d Press **Go To** and then enter the code shown below to respond to these programming questions:
 - Enter **08**. For details, see "Q8: Dialer (0-1)" on page 54.
 - Enter **11**. For details, see "Q11: CS #1 Phone Number (0-25 Digits)" on page 55.
 - Enter **12**. For details, see "Q12: CS #1 Account Number (4 Digits)" on page 55.

IMPORTANT: You must program the module in order to use it with the Control Panel.

Figure 11 Control Panel with 2GIG Go!Control POTS Module

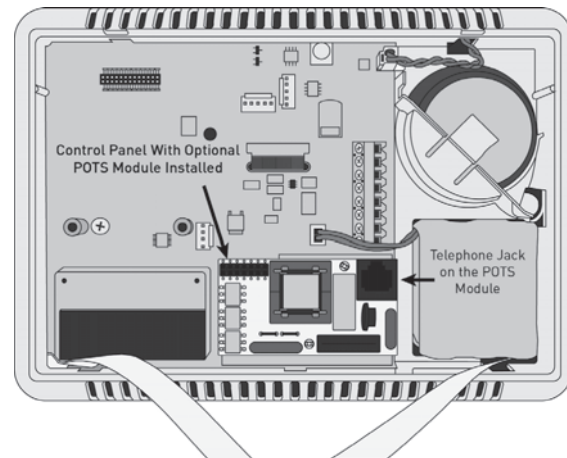

GSM (CELLULAR) RADIO MODULE

If installing the GSM (Cellular) Radio Module, see below:

Figure 12 In-Wall Antenna Installation

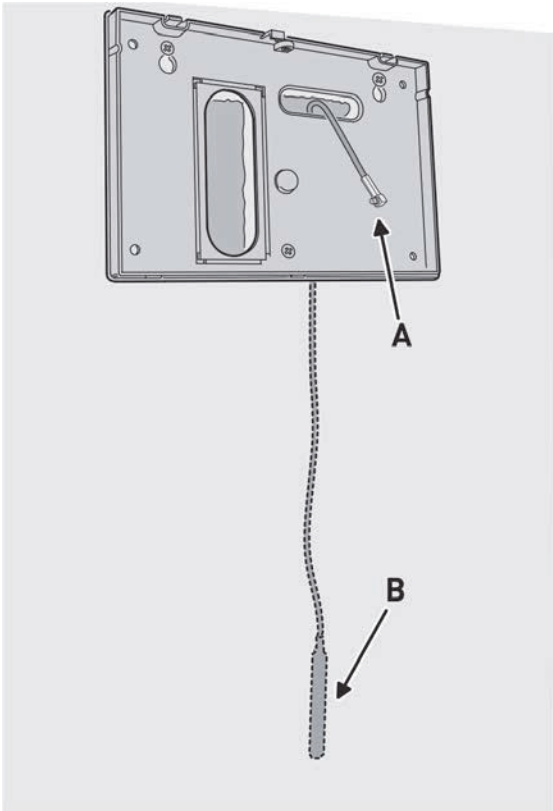

- A GSM (Cellular) Radio Module Connector
- B End of antenna hangs down inside the wall

NOTE: The routing of the antenna wire is critical. **You must route the wire exactly as directed or cell radio interference will occur.**

- 1 When using external antennas, plug the antenna connector into the GSM (Cellular) Radio Module. The antenna drops into the wall or mounts in the attic with the cable passing through the slot in the Control Panel's mounting plate.

Figure 13 Attic Antenna Installation

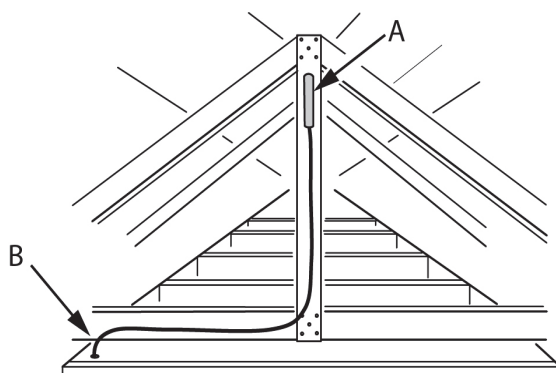

- A Attic antenna mounted as high as possible
- B Coaxial cable to Control Panel

The GSM (Cellular) Radio Module should already be activated by the factory. If not, contact the Remote Service Provider. For the GSM (Cellular) Radio Module to function, it must be activated before it can be enrolled. Enrollment is accomplished by creating an account with the provider.

CONTROL PANEL WIRING

The following diagram shows you the Control Panel wiring.

Figure 14 Control Panel Wiring Diagram

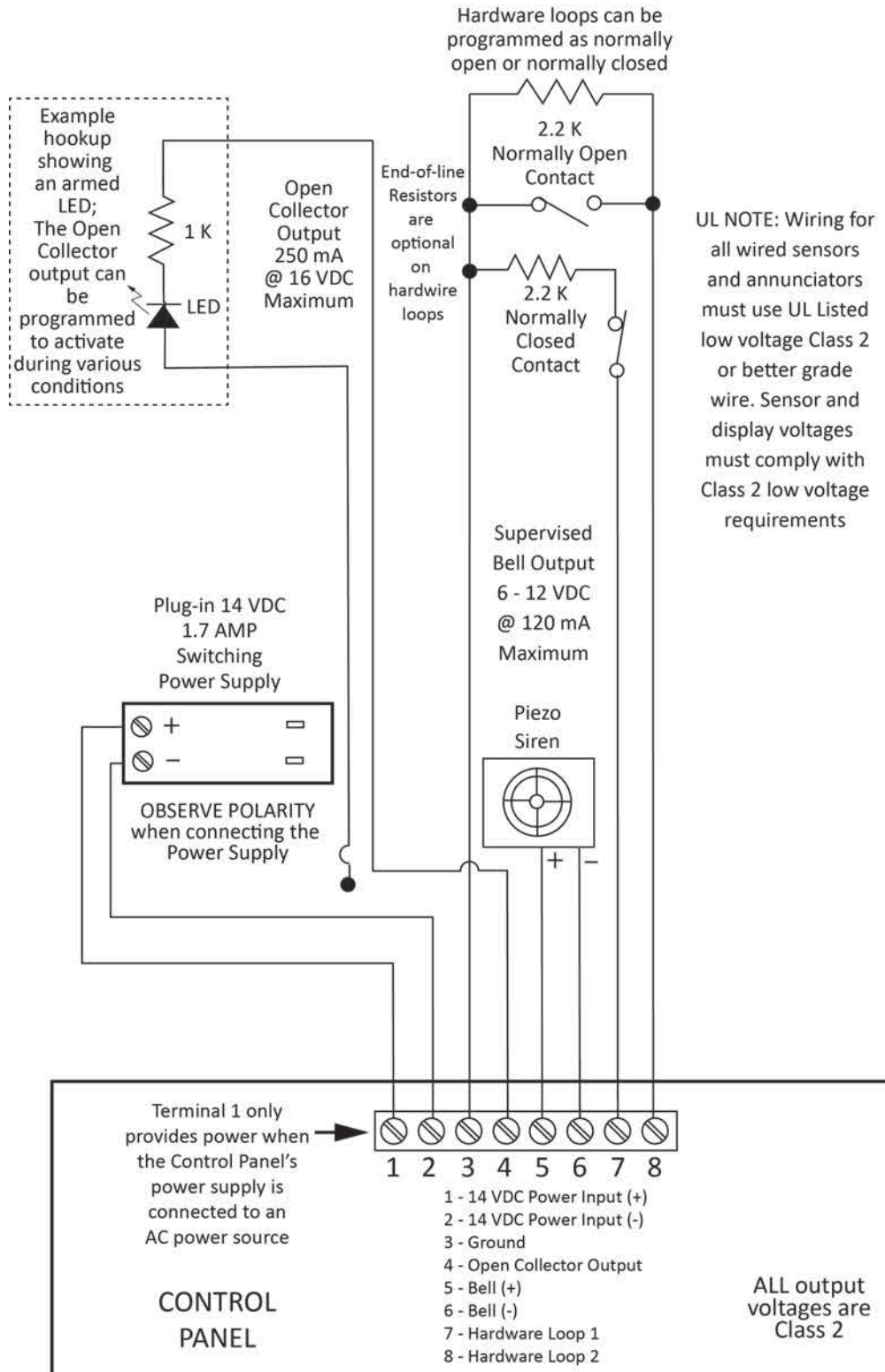

Control Panel Wiring

The third-hand hanging strap allows you to hang the Control Panel on the mounting plate during installation.

- 1 Hang the Control Panel on the mounting plate by the third-hand hanger strap.
- 2 Connect the hardwire loop, external sounder, and open collector output wiring (if used) to the Control Panel's terminal block.
- 3 Plug the telephone line (if used) into the telephone jack on the POTS Module.

Figure 15 Third-Hand Hanging Strap

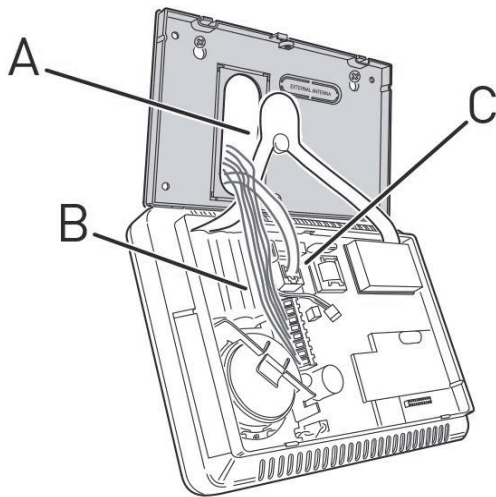

- A Third-hand hanging strap
- B Hardwire loops, external sounder, and open collector output connected to terminals.
- C Telephone jack on the POTS module

Terminal Block Wiring Diagram

Figure 16 Terminal Block Wiring Diagram

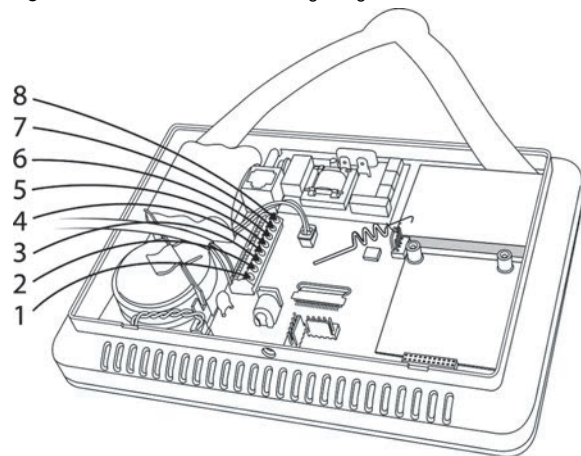

- 1 14 VDC Power Input (+)
- 2 14 VDC Power Input (-)
- 3 Ground
- 4 Open Collector
- 5 Bell (+)
- 6 Bell (-)
- 7 Hardwire Loop 1
- 8 Hardwire Loop 2

BACKUP BATTERY CONNECTION AND POWER SUPPLY WIRING

The backup battery connects to the Control Panel's circuit board with a two (2)-pin header assembly.

The power supply features a two (2)-position terminal block for connecting the power supply to the Control Panel power terminals (connection wire not included).

- 1 Locate an unswitched wall outlet for the plug-in power supply.

WARNING: Never connect the power supply to switch-controlled outlet.

- 2 Route two (2)-conductor wire from the power supply location to the Control Panel mounting plate. For wire size and maximum length, see "Wire Size and Length" on page 21.
- 3 Being careful to observe polarity, connect the wire to the power supply's DC+ and DC- terminals. Do NOT plug the power supply into an outlet at this time.
- 4 Being careful to observe polarity, connect the wire to the Control Panel input terminals 14VDC (+) Terminal 1 and 14VDC (-) Terminal 2.

NOTE: Grounding of the Control Panel is NOT required for proper operation.

- 5 Plug the backup battery pack's connector into the connector on the Control Panel's circuit board. The Control Panel does not recognize that the battery is connected until AC power is connected to the power supply.

NOTE: The standard backup battery that is included with all 2GIG Control Panels does not support UL 985 installations. To comply with the secondary supply requirement in *UL 985: Household Fire Warning System Units*, install the 2GIG Console Battery Pack (This is a high-capacity 2600mAh Ni-MH replacement battery pack).

Wire Size and Length

To ensure proper operation, do NOT exceed the following maximum length for the wire size installed:

Wire Size	Maximum Length
22 AWG	55 ft (16.8 m)
20 AWG	85 ft (25.9 m)
22 AWG 2-pairs (19 AWG equivalent)	110 ft (33.5 m)
18 AWG	135 ft (41.1 m)

TIP: To ensure that the appropriate wire size and length is installed, measure the voltage between the power connection terminals at the back of the Control Panel. The voltage measured must not fall below 11 volts DC or the Control Panel may display nuisance “AC Power Loss” messages and send AC Loss Reports to the Central Station. See “Q52: AC Loss Reports to CS (0-1)” on page 61.

NOTE: In the United States, wiring routed inside walls, ceilings, and floors must comply with requirements of *ANSI/NFPA 70: National Electrical Code (NEC)* and local building codes. For wiring from the output of the 2GIG Class II Power Supply, wiring rated CL2, CL2X, CL2R, or PLTC is recommended to satisfy these requirements. If this wiring is installed in an air plenum (space used for environmental air exchange) it must be rated CL2P (plenum-rated).

Figure 17 Power Supply Wiring

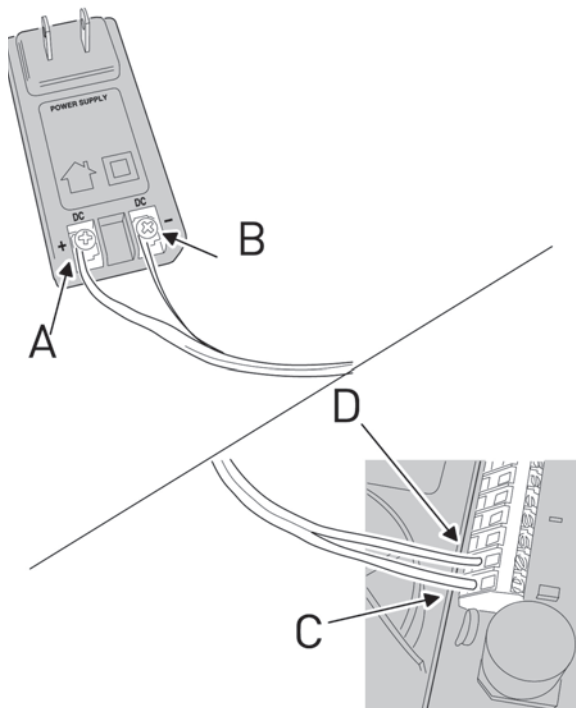

- A Left Terminal 14 VDC (+)
- B Right Terminal 14 VDC (-)
- C 14 VDC (+) Terminal 1
- D 14 VDC (-) Terminal 2

CONTROL PANEL AND POWER SUPPLY MOUNTING

After all the wiring complete, follow these steps to power up the Control Panel:

- 1 Place the bottom of the Control Panel over the lower lip of the backplate and flip the Control Panel upwards. Then push the Control Panel over the mounting bracket until it snaps into place. It with the retaining screw.
- 2 Peel off the adhesive backing from the power supply retaining bracket and attach the bracket to the outlet with a wall plate screw.

Figure 18 Connecting Battery and Closing Panel

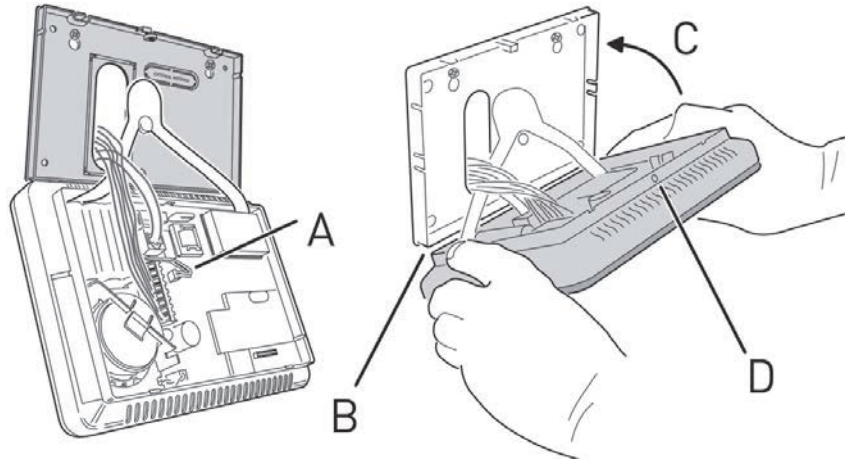

- A Connect battery
- B Align mounting plate inside of console bottom edge
- C Swing console up and snap into the mounting plate
- D Secure console with screw in retaining hole

- 3 Spread the retaining bracket ears and plug the Control Panel's power supply into the unswitched wall outlet. Slots are provided on the bracket to secure the power supply with a zip-tie.
- 4 After about five (5) seconds, the Control Panel indicates that power has been applied. If the Control Panel does not power up, check the power supply polarity.

Figure 19 Securing the Power Supply

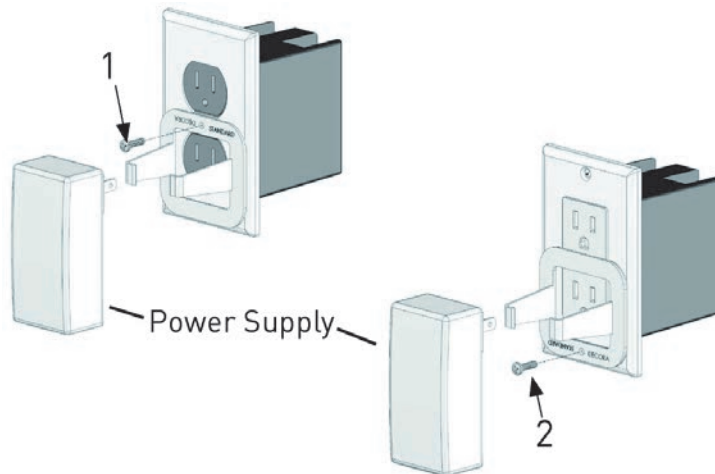

- 1 Place the screw here for a bracket on a standard style outlet.
- 2 Place the screw here for a bracket on a Decora style outlet.

NOTE: In the United States (and other countries where it is required), use the power supply retaining bracket. In Canada, the power supply retaining bracket is not required.

COMMERCIAL INSTALLATIONS

For commercial installations, the Control Panel is designed for use only as a burglary alarm system, and not for fire protection. Installation location and wiring methods shall be in accordance with *ANSI/NFPA 70: National Electric Code*, *UL 681: Installation and Classification of Burglar and Holdup Alarm Systems*, and *UL 827: Central-Station Alarm Services*.

NOTE: All entries and exits within a commercial installation setup must be protected according to the criteria provided by *UL 681: Installation and Classification of Burglar and Holdup Alarm Systems*.

Figure 20 Commercial Installations

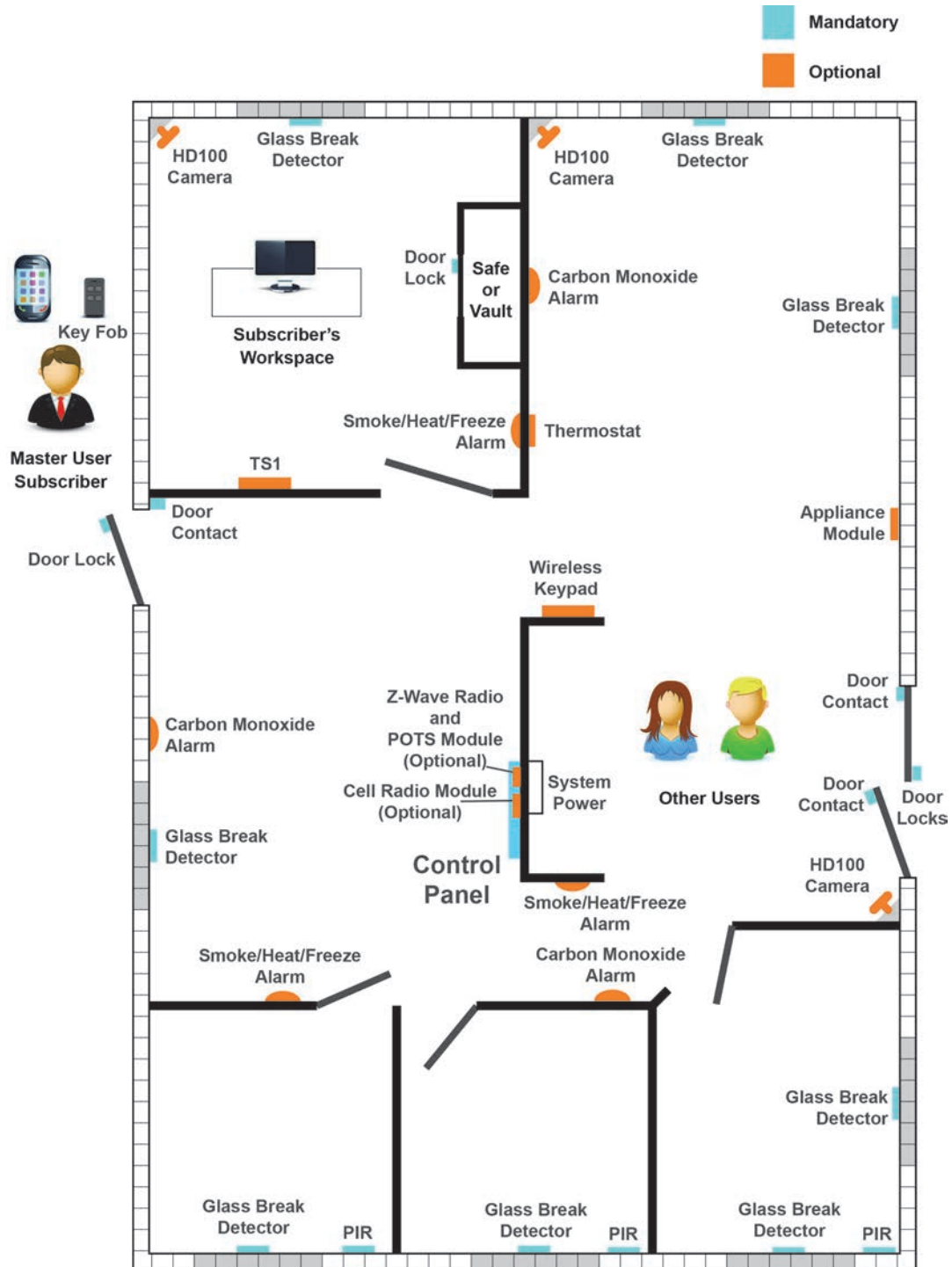

NFPA STANDARD 72

Smoke detectors must be installed in accordance with *National Fire Protection Association (NFPA) Standard 72: National Fire Alarm and Signaling Code*, which reads as follows:

2-1.1.1 Smoke alarms shall be installed outside of each separate sleeping area in the immediate vicinity of the bedrooms and on each additional story of the family living unit including basements and excluding crawl spaces and unfinished attics. In new construction, a smoke alarm shall be installed in each sleeping room.

2-1.1.2 For family living units with one or more split levels (i.e., adjacent levels with less than one full story separation between levels), a smoke alarm shall suffice for an adjacent lower level, including basements. (Exception: Where there is an intervening door between one level and the adjacent lower level, a smoke alarm shall be installed on the lower level.)

- Ceiling mounted smoke alarms should be located in the center of the room or hall, or not less than 4 inches from any wall. When the alarm is mounted on a wall, the top of the alarm should be 4 to 12 inches from the ceiling.
- Do not install smoke alarms where normal ambient temperatures are above 100°F (37.8°C), or below 40°F (4°C). Also, do not locate alarm in front of air conditioners, heating registers, or other locations where normal air circulation will keep smoke from entering the detector.

A-2.5.2.1 Smoke Detection - Are More Smoke Alarms Desirable? The required number of smoke alarms might not provide reliable early warning protection for those areas separated by a door from the areas protected by the required smoke alarms. For this reason, it is recommended that the residential user consider the use of additional smoke alarms for those areas for increased protection. The additional areas include the basement, bedrooms, dining room, furnace room, utility room, and hallways not protected by the required smoke alarms. The installation of smoke alarms in kitchens, attics (finished or unfinished), or garages is not normally recommended, as these locations occasionally experience conditions that can result in improper operation or false alarms."

NOTE: Smoke alarms are not to be used with detector guards unless the combination has been evaluated and found suitable for the purpose.

Figure 21 Recommended Smoke Alarm Locations

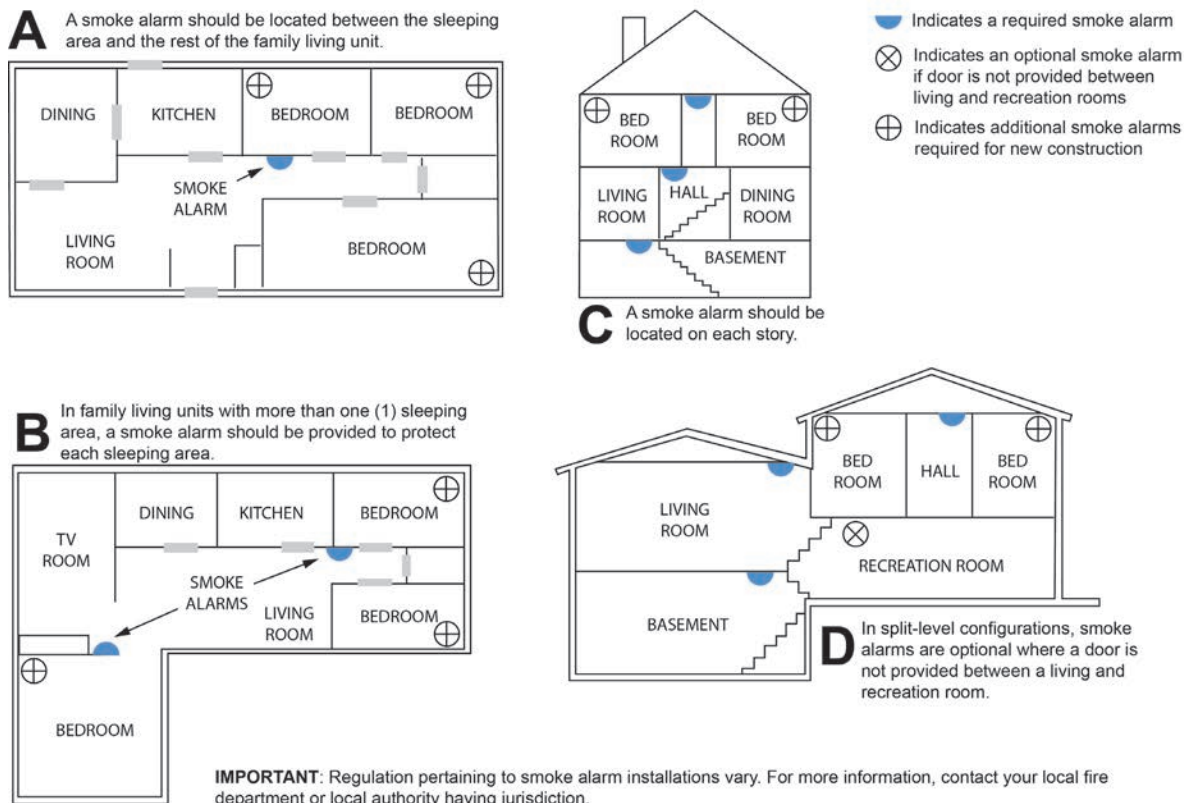

MAIN DISPLAY SCREENS

HOME SCREEN

To go to the **Home** screen, press the **Home**  button on the Control Panel. The Home screen reveals:

- **System Status.** The status of the system appears at the top left of the screen. For example, *System Armed* or *System Ready, Not Armed*.
- **Conditional Messages.** A variety of conditional messages will also appear under the System Status.
- **Time, Date and Weather.** The current time, date, and daily weather forecast (when the system includes the GSM (Cellular) Radio Module and has an active account with a Remote Services Provider)
- **System Status Icons.** Icons in the top-right corner reveal a variety of conditions. See "*System Status Icons*" on page 29.

Buttons on this page include:

- **Security.** Opens the **Security** screen. See *Security Screen*.
- **Services.** Opens the **Services** screen. See the Control Panel's *User Guide* for more information.
- **Silent Control.** Opens the **Bypass** screen. See the Control Panel's *User Guide* for more information.
- **Display OFF.** Turn OFF the Control Panel screen.

Figure 22 Home Screen

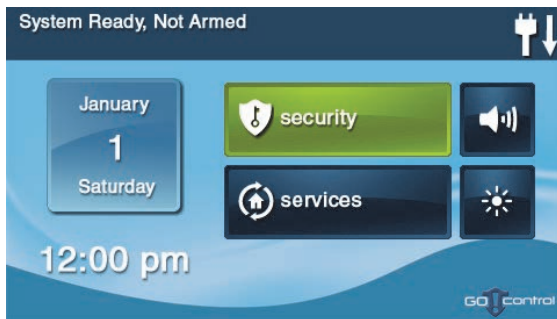

SECURITY SCREEN

The **Security** screen displays three (3) buttons for **Arm**, **Menu**, and **Status**. It also shows the time, date, and weather display.

Figure 23 Security Screen

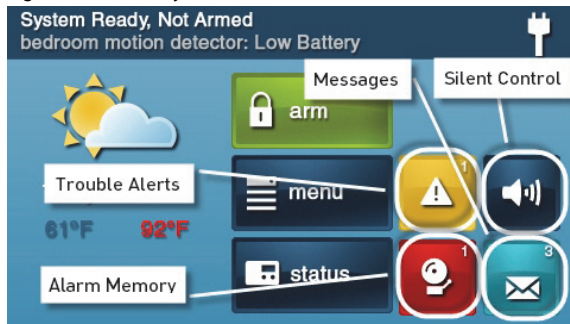

Under the appropriate conditions, additional buttons include:

- **Trouble Alerts.** Displays when trouble alerts are pending.
- **Messages.** Displays when messages are pending.
- **Alarm Memory.** Displays when alarms are pending.

For information about the **Silent Control** button, see the Control Panel's *User Guide*.

ARMING SCREEN

The **Arming** screen lets users arm the security portion of the system. It displays the system status and arming buttons for **Stay** and **Away** mode. It also includes these options:

- **Entry Delay** Select this check box to arm the system with an entry delay. Clear the check box to arm the system without an entry delay. See "*(01) Exit/Entry 1*" on page 36 and "*(02) Exit/Entry 2*" on page 36.
- **Silent Exit** Select this check box to silently arm the system without sounding the exit delay beeps. Arming the system in **Stay** mode always uses silent exit.

Figure 24 Arming Screen



MENU SCREEN

The **Menu** screen includes the **Arm** and **Toolbox** buttons.

Figure 25 The Menu Screen

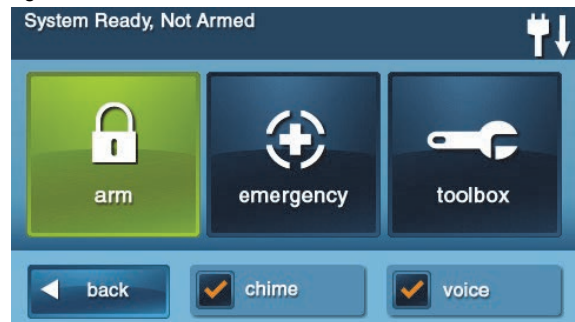

If any of the 24-hour emergency options are enabled, an **Emergency** button also appears. It also includes these options:

- **Chime** Select this check box to enable system chimes and clear the check box to disable system chimes. Note that chimes can also be enabled or disabled for each sensor number by pressing **Toolbox > Chimes Setup**.
- **Voice** Select this check box to enable voice announcements for the system. Voice announcements always sound during alarm conditions.

SYSTEM STATUS SCREEN

The **System Status** screen lists system status and any alerts. The date and time of alerts are listed in the displayed log. One option button for **Silence** is displayed; it temporarily stops the announcement of the system status during the status display.

Figure 26 System Status Screen

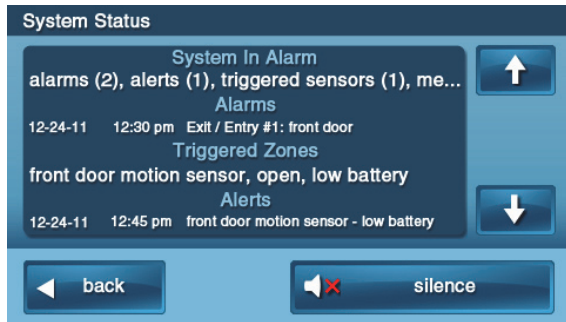

TOOLBOX AND INSTALLER TOOLBOX

The Control Panel includes two (2) different toolboxes for programming the system:

- **User Toolbox.** Individuals with a *user code* can access basic programming functions. The user toolbox is simply called, the Toolbox.
- **Installer Toolbox.** Individuals with the *installer code* can access both the basic programming functions of the user Toolbox and the more advanced programming functions of the Installer Toolbox.

TOOLBOX SCREENS

The Toolbox provides individuals who possess a *user code* with the ability to access basic programming functions.

Accessing the Toolbox

To access the basic Toolbox screens:

- 1 At the **Home** screen, press **Security**, then **Menu**, and then **Toolbox**.
- 2 At the **Enter Your Code to Access the Toolbox** screen, enter a *user code*. The default user code is 1111.

Figure 27 Enter Your Code Screen

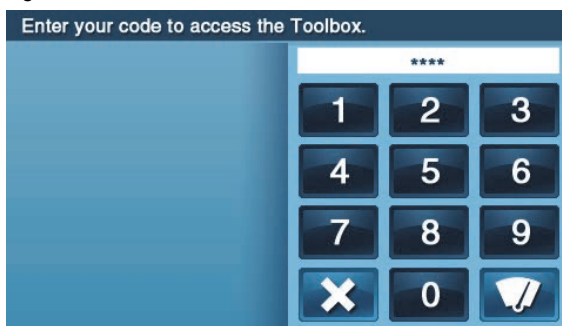

- 3 When the **Toolbox (1 of 3)** screen appears, press the left and right arrows to scroll between the different screens.

Each screen provides different buttons for accessing different features.

Figure 28 Toolbox (1 of 3)

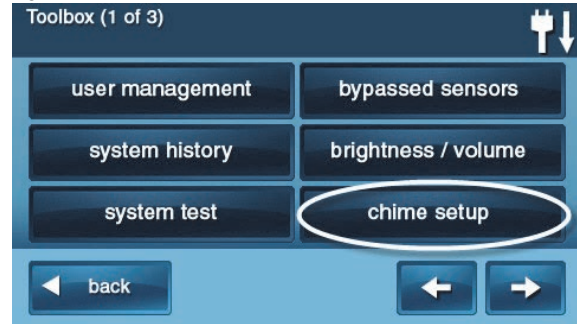
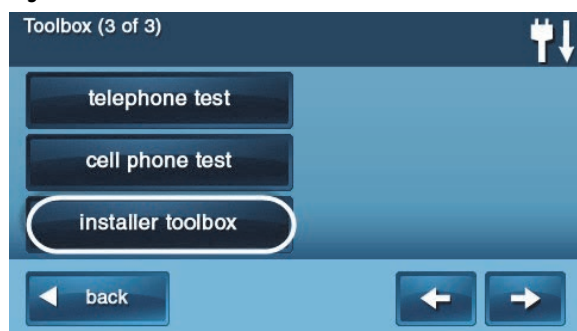

Figure 29 Toolbox (2 of 3)



Figure 30 Toolbox (3 of 3)



INSTALLER TOOLBOX SCREENS

The **Installer Toolbox** screen provides individuals who possess the installer code with the ability to access a variety of system configuration and testing buttons.

NOTE: The Installer Toolbox is only accessible when the system is disarmed. The installer code does NOT disarm the system. You must know the user code to disarm the system. Accessing the Installer Toolbox

Accessing the Installer Toolbox

There are two (2) ways to access the Installer Toolbox on the Control Panel:

- 1 At the **Home** screen, press the system logo in the lower-right corner and then press the **Installer Toolbox** button. Finally, enter the installer code.
OR
- 2 At the **Home** screen, press **Security** > **Menu** > **Toolbox**. Then press the **Installer Toolbox** button and enter the installer code.

The default installer code is 1561. To learn how to change this code, see *Q43: Installer Code (4 Digits)*.

Accessing the System Configuration for System and Sensor Programming

To access the system configuration screens for programming sensors into the system:

- 1 Disarm the system by pressing Disarm and entering a user code. The default user code is 1111.
- 2 Access the Installer Toolbox. See *Accessing the Installer Toolbox* above.
- 3 At the **Installer Toolbox** screen, press the **System Configuration** button.

NOTE: The other buttons let you restore the default Control Panel settings and provides access to a variety of system tests.

Figure 31 Installer Toolbox Screen

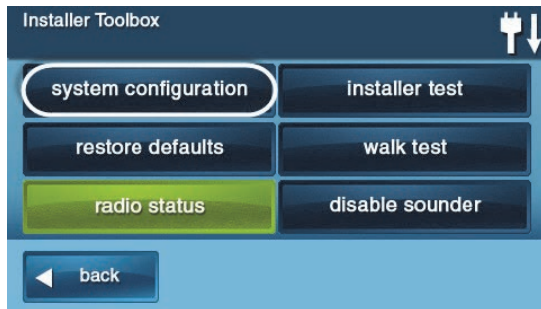

After pressing the System Configuration button, the first programming question appears. To learn more, see *System Configuration Screens*.

SYSTEM CONFIGURATION SCREENS

Use the System Configuration screens to program sensors into the system. Installers can access the System Configuration screens as described in *Accessing the System Configuration for System and Sensor Programming*.

The System Configuration screens present installers with a sequential list of programming questions. For a list of all available programming questions, see "Programming Question Table" on page 33.

Figure 32 Q1: Select RF Sensor # (01 to 48).

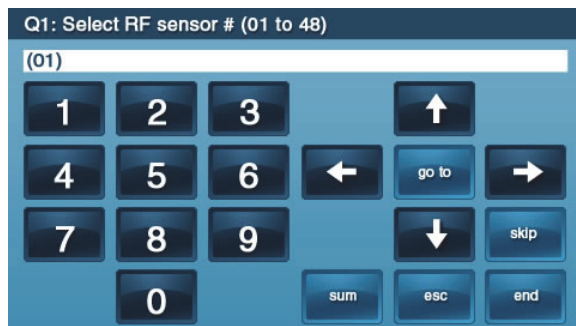

TIP: To simplify programming, questions are arranged so that commonly used values appear early in the question sequence.

SYSTEM STATUS ICONS

The top line of the Control Panel's display is the status bar that shows the current system mode, the status of the sensors, and any current system trouble alerts. Special icons are displayed on the right side to provide visual indications of the system's current condition.

Figure 33 System Status Icons



- A Status Bar
- B Status Icons

AC POWER ON/OFF



Figure 34 AC Power ON

The AC Power icon shows the status of the AC power to the Control Panel. A WHITE plug appears when AC power is present.



Figure 35 AC Power OFF

The AC Power icon shows the status of the AC power to the Control Panel. A RED "X" appears over the WHITE plug when AC power is absent.

PHONE LINE FAILURE



Figure 36 Phone Line Failure

If the Control Panel detects that the telephone line is disconnected, the phone line failure icon appears.

SOUNDER DISABLED



Figure 37 Sounder Disabled

If the system's internal sounder has been lowered and external sounder has been disabled by the installer for testing, the sounder disabled icon appears. It also flashes to indicate silent arming.

LOW BACKUP BATTERY



Figure 38 Low Backup Battery

If the Control Panel's backup battery tests low, the low backup battery icon appears.

TEST MODE



Figure 39 Test Mode

This icon displays when the system is in Walk Test mode.

TOUCH SCREEN KEYPAD TRAFFIC



Figure 40 Touch Screen Keypad Traffic

An up arrow indicates the panel is sending information to the touch screen keypad (if installed). A down arrow indicates the touch screen keypad is sending information to panel.

CELL RADIO



Figure 41 Cell Radio

If the option GSM (Cellular) Radio Module is installed, the Cell Radio icon appears while the Control Panel is receiving Over-the-Air (OTA) firmware updates.

INTERIOR SENSOR OPEN



Figure 42 Interior Sensor Open

If an interior sensor is open (or a motion detector has just been activated) this icon appears. As a warning, the icon flashes during arming.

PROGRAMMING NAVIGATION

When the installer is using the System Configuration menus, the Control Panel will present each programming question sequentially. Most programming questions have a single numeric value response or a simple enabled/disabled selection. Some programming questions have sub-options that can be set. These sub-options are displayed for the question selected and can be accessed through navigation keys on the display.

NAVIGATION ARROWS & GO TO BUTTON

The programming question screens display up, down, left, and right navigation arrows. Use these arrows to scroll through the programming questions and to select sub-options.

Press the **Go To** button and then enter a two (2)-digit code to jump directly to a programming question. See "Programming Question Table" on page 33. The **Go To** button changes to **Cancel** when waiting for you to enter a question number. Press **Cancel** to back out.

Figure 43 Navigation Arrows & Go To Button



QUESTIONS WITHOUT SUB-OPTIONS

Most of the programming questions do not have sub-options. They navigate as follows. Questions without sub-options do not display a **Skip** button.

Figure 44 Questions without Sub-options



- The ↑ and ↓ arrows select the next or previous programming question.
- The ← and → arrows choose values for the question or move the cursor left and right along the white data entry field.

QUESTIONS WITH SUB-OPTIONS

Some of the programming questions have sub-options. They navigate as follows. Questions with sub-options display a **Skip** button during the question. The **Skip** button advances to the next programming question/section.

- The ↑ and ↓ arrows select the next or previous programming sub-question.
- The ← and → arrows choose values for the question or move the cursor left and right along the white data entry field.

Figure 45 Questions with Sub-options



QUESTIONS WITH DATA ENTRY

Some of the programming questions require entering numeric or alphabetic data. For devices that can be named, the Control Panel contains a large vocabulary with words to choose from. See "Voice Descriptors" on page 38.

- The **Insert** button displays a word from the vocabulary. Use the ← and → arrows to scroll through the word list, or enter the corresponding three (3)-digit code. See "Voice Descriptors" on page 38.
- The **Backspace** button moves the cursor to the left, deleting one (1) character at a time.
- The **Delete** button deletes a character to the right of the cursor, or any characters that are highlighted.
- The **Forward** button highlights the next word in multi-word data fields.
- The **Back** button highlights the previous word in multi-word data fields. The **Back** button displays the previous screen in some cases.
- When the **Shift** button is displayed, pressing it will display alternate characters on the keypad that can be used for data entry.

Figure 46 Questions with Data Entry



ADDITIONAL BUTTONS

Depending on the programming question, additional buttons may be displayed on screen:

- The **Esc** (Escape) button serves as an "undo". Pressing **Esc** restores the value that was previously stored for the question or sub-question.
- The **Sum** (Summary) button displays a summary of the values stored for the programming question and sub-options.
- The **End** button displays a summary of the values stored for the entire Control Panel memory.
- The **Learn** button is used to set the system to receive a sensor's serial number during programming.
- The **Paste** button repeats the last sensor serial number entered.
- The **Exit** button exits programming.

Figure 47 Other Buttons Displayed



PROGRAMMING OUTLINE

Each system installed will require programming. Most installations being performed by the professional alarm installer for a specific organization will have common values set in every Control Panel that is reporting to the Central Station. Other programming values, such as the account number and sensor setup, may be unique for each installation.

Use the following outline to guide you through the installation process. Understanding the Control Panel's programming structure will help to save time during each installation.

At this stage the following should be already completed:

- All wired sensors installed
- All wireless sensors installed
- Control Panel mounted, connected, and powered up

1 At the **Home** screen, press the system logo in the lower right corner.

Figure 48 The Home Screen



NOTE: You can also click the Installer Toolbox button from the system's **Toolbox (3 of 3)** screen.

- 2 Enter the *installer code* (the default installer code is 1561) in the **Enter Your Code to Access the Toolbox** screen.
- 3 At the Installer Toolbox, press **System Configuration**. Then begin the "*RF Sensor Programming Questions*" on page 42.
- 4 After programming all of the required sensors into the Control Panel, press **End**, then **Exit**, to save the changes.
- 5 After the Control Panel restarts, press **Security > Menu > Toolbox**.
- 6 When prompted, enter the *master user code*. The default master user code is 1111.
- 7 Press the **User Management** button and then setup the user codes. Be sure to set up the Duress Code as User #8. Press **Back** when finished.
- 8 Press **Brightness/Volume** and set the levels for the installation.
- 9 The volume setting does not affect the volume of *alarm* sounds.
- 10 Press → to view the second toolbox screen.
- 11 Press **Back Light Timeout** and set the display lighting timeout.
- 12 Press **Set Date** and **Set Time** and set the calendar and clock. If the GSM (Cellular) Radio Module is installed, the date and time sets automatically.
- 13 Press the  button to return to the Home screen.

After completing all setup and programming tasks, refer to the Control Panel's *User Guide* for information about operating the system. Check off the programmed options for the system in the *User Guide*.

NOTE: Instruct the end user about proper system operations, and leave the *User Guide* at the installation site for reference.

ANSI/SIA CP-01 COMPLIANCE

Several programmable options have the defaults pre-set to provide compliance with the *American National Standards Institutes/Security Industry Association CP-01 Control Panel Standard*. The table below details the settings that comply with *ANSI/SIA CP-01* and permanently programmed into the Console. The *ANSI/SIA CP-01* settings documented in the table below cannot be changed:

Programming Question	ANSI/SIA CP-01 Setting	Range
Q1 Select RF Sensor # Dialer Delay	30 Seconds	(0) Disabled or (1) Enabled
Q2 Select Wired Sensor Dialer Delay (0 to 1)	30 Seconds	(0) Disabled or (1) Enabled
Q5 Enter Exit Delay, in Seconds (45-120)	60 Seconds	45-120 Seconds
Q6 Enter Entry Delay 1, in seconds (45-120)	30 Seconds	30-240 Seconds
Q7 Enter Entry Delay 2, in seconds (45-120)	45 Seconds	30-240 Seconds
Q10 Enter Call Waiting Disable Code (0-6 digits)	No Default Code	0-6 Digits
Q20 Select Swinger Shutdown Count (1 to 6)	(2) Two Trips	1-6 Trips
Q26 Select Auto Stay (0 to 1)	(1) Enabled	(0) Disabled or (1) Enabled
Q27 Exit Delay Restart (0 to 1)	(1) Enabled	(0) Disabled or (1) Enabled
Q31 Enter Cancel Time, in Minutes (5-255)	5 Minutes	6-254 Minutes
Q32 Select Cancel Display (0 to 1)	(1) Enabled	(0) Disabled or (1) Enabled
Q35 Select Abort Window Dialer Delay (0 to 2)	30 Seconds	15 or 45 Seconds
Q78 Select Output	(11) Follows Internal Sounder Alarm	NOTE: See "Q78: Output" on page 64

PROGRAMMING QUESTION TABLE

Q#	Question	Default
Q1	Select RF Sensor # (01 to 48)	
	Select RF Sensor # Type	(00) Unused
	Select RF Sensor # Equipment Type	Varies by RF sensor type Only shown for some sensor types
	Select RF Sensor # Equipment Code	(0000) Other
	Enter RF Sensor # Other Equipment Code (0-9999)	0 NOTE: Only shown if (0000) Other is selected as the RF Sensor # Equipment Code
	Enter RF Sensor # Serial Number (7 digits)	0000000
	Select RF Sensor # Equipment Age (0 to 1)	(0) New
	Select RF Sensor # Loop Number (1 to 3)	Varies with sensor model selected
	Select RF Sensor # Dialer Delay (0 to 1)	(1) Enabled‡ (2) Disabled (for Fire and CO only)
	Construct RF Sensor # Voice Descriptor	No Default Setting
	Select RF Sensor # Reports (0 to 1)	(1) Enabled
	Select RF Sensor # Supervised (0 to 1)	(1) Enabled
	Select RF Sensor # Chime (0 to 13)	(0) Disabled
Q2	Select Wired Sensor # (1 to 2)	
	Select Wired Sensor # Type	(00) Unused
	Select Wired Sensor # Equipment Age (0 to 1)	(0) New
	Select Wired Sensor # Normal State (0 to 3)	(0) Not Used
	Select Wired Sensor # Dialer Delay (0 to 1)	(1) Enabled‡
	Construct Wired Sensor # Voice Descriptor (0 to 1) ‡	No default
	Select Wired Sensor # Reports (0 to 1)	(1) Enabled
	Select Wired Sensor # Chime (0 to 13)	(0) Disabled
Q3	Select Fob # (1 to 8)	
	Select Fob # Used (0 to 1)	(0) Unused
	Select Fob # Equipment Code (0000)	(0000) Other
	Enter Fob # Other Equipment Code (0 to 9999)	0 NOTE: Only shown when (0000) other is selected as the Fob # Equipment Code
	Enter Fob # Serial Number (7 digits)	0000000
	Select Fob # Equipment Age (0 to 1)	(0) New
	Select Fob # Emergency Key (0 to 4)	(0) Disabled
	Select Fob # Key 2 Can Disarm (0 to 1)	(1) Enabled
	Construct Fob # Voice Descriptor	Keyfob #
	Select Fob # Arm No Delay (0 to 1)	(0) Disabled
	Select Fob # Key 4 Output (0 to 2)	(0) Disabled
Q4	Select RF Keypad # (1 to 4)	
	Select RF Keypad # Used (0 to 1)	(0) Unused
	Select RF Keypad # Equipment Code	(0000) Other
	Enter RF Keypad # Other Equipment Code (0 to 9999)	0 NOTE: Only shown if (0000) Other is selected as the RF Keypad # Equipment Code
	Enter RF Keypad # Serial Number (7 digits)	0000000
	Select RF Keypad # Emergency Age (01)	(0) New
	Select RF Keypad # Emergency Keys (01)	(1) Enabled
	Construct RF Keypad # Voice Descriptor	Keypad #
Q5	Enter Exit Delay, in Seconds (45 to 120)	60 seconds‡
Q6	Enter Entry Delay 1, in Seconds (30 to 240)	30 seconds‡
Q7	Enter Entry Delay 2, in Seconds (30 to 240)	45 seconds‡
Q8	Select Dialer (0 to 1)	(0) disabled
Q9	Enter Dialing Prefix (0 to 4 digits)	No default
Q10	Enter Call Waiting Disable Code (0 to 6 digits)	No default‡
Q11	Enter CS #1 Phone Number (0 to 25 digits)	No default
Q12	Enter CS #1 Account Number (4 digits)	No default
Q13	Select Two-Way Voice (0 to 2)	(1) Stay Online
Q14	Select Silent Panic/Burglary Listen Only (1 to 1)	(1) Enabled
Q15	Select Dialing Type (0 to 1)	(0) Touch Tone
Q16	Select Police Emergency Key (0 to 2)	(1) Audible
Q17	Select Fire Emergency Key (0 to 1)	(1) Audible

Q#	Question	Default
Q18	Select Emergency Key (0 to 1)	(1) Audible
Q19	Select Quick Arming (0 to 1)	(1) Enabled
Q20	Select Swinger Shutdown Count (1 to 6)	(2) Two Trips‡
Q21	Select Siren Supervision Time (0 to 3)	(0) Disabled
Q22	Enter CS Lack of Usage Notification Time, in Days (0-255)	7 Days
Q23	Enter Radio Modem Network Failure Time (0-255)	30 Minutes
Q24	Select Radio Network Failure Causes Trouble (0 to 1)	(1) Enabled
Q25	Select Radio Modem Network Failure Reports (0 to 1)	(1) Enabled
Q26	Select Auto Stay (0 to 1)	(1) Enabled‡
Q27	Select Exit Delay Restart (0 to 1)	(1) Enabled‡
Q28	Select Quick Exit (0 to 1)	(1) Enabled
Q29	Enter Periodic Test, in Days (0-255)	30 Days
Q31	Enter Cancel Time, in Minutes (5-255)	5 Minutes‡
Q32	Select Cancel Display (0 to 1)	(1) Enabled‡
Q33	Select Cross Sensor 47-48 (0 to 1)	(0) Disabled
Q34	Enter Cross Sensor Timeout, in Seconds (10-120)	10 Seconds
Q35	Select Abort Window Dialer Delay (0 to 2)	(1) 30 Seconds‡
Q36	Select Burglary Bell Cutoff (0 to 4)	(0) 4 Minutes
Q37	Select Fire Bell Cutoff (0 to 4)	(0) 4 Minutes
Q38	Enter Time to Detect AC Loss, in Minutes (1-30)	10 Minutes
Q39	Select Random AC Loss Report Time (0 to 1)	(1) Enabled
Q40	Enter CS #2 Phone Number (0-25 digits)	No Default
Q41	Enter CS #2 Account Number (4 digits)	No Default
Q42	Select Remote Control Phone (0 to 3)	(3) Data and Voice
Q43	Enter Installer Code (4 digits)	1561
Q44	Select Lock Installer Programming (0 to 2)	(0) Disabled
Q45	Select Lock Default Programming (0 to 2)	(0) Default All
Q46	Select Trouble Doesn't Sound at Night (0 to 1) *	(1) Enabled
Q47	Select Troubles Resound After Holdoff (0 to 7)	(0) Disabled
Q48	Enter Download CSID (6 digits)	000000
Q49	Select Programming Mode Entry Reports to CS (0 to 1)	(0) Disabled
Q50	Select Trouble Reports to CS (0 to 1)	(1) Enabled
Q51	Select Manual Bypass Reports to CS (0 to 1)	(0) Disabled
Q52	Select AC Loss Reports to CS (0 to 1)	(1) Enabled
Q53	Select System Low Battery Reports to CS (0 to 1)	(1) Enabled
Q54	Select RF Low Battery Reports to CS (0 to 1)	(1) Enabled
Q55	Select Opening Reports to CS (0 to 1)	(0) Disabled
Q56	Select Closing Reports to CS (0 to 1)	(0) Disabled
Q57	Select Alarm Restore Reports to CS (0 to 1)	(0) Disabled
Q58	Select Trouble Restore Reports to CS (0 to 1)	(1) Enabled
Q59	Select Bypass Restore Reports to CS (0 to 1)	(0) Disabled
Q60	Select AC Restore Reports to CS (0 to 1)	(1) Enabled
Q61	Select System Low Battery Restore Reports to CS (0 to 1)	(1) Enabled
Q62	Select RF Low Battery Restore Reports to CS (0 to 1)	(1) Enabled
Q63	Select Phone Fail Detect (0 to 1)	(0) Disabled
Q64	Select Smart Test Reports (0 to 1)	(0) Disabled
Q65	Select RF Jam Causes Trouble (0 to 1)	(0) Disabled
Q66	Select Daylight Saving (0 to 1)	(1) Enabled
Q67	Select Daylight Saving Start Month (01 to 12)	(03) March
Q68	Select Daylight Saving Start Sunday (1 to 7)	(2) 2nd
Q69	Select Daylight Saving End Month (01 to 12)	(11) November
Q70	Select Daylight Saving End Sunday (1 to 7)	(1) 1st
Q71	Select System Tamper Causes Trouble (0 to 1)	(1) Enabled
Q72	Select Quick Bypass (0 to 1)	(0) Disabled
Q73	Select Disarming Keyfob After Alarm Alert (0 to 1)	(0) Disabled
Q74	Select Keyfob Arm/Disarm Confirmation (0 to 1)	(0) Disabled
Q75	Select Auto Unbypass for Manual Bypass (0 to 1)	(1) Enabled
Q76	Select Force Bypass Reports (0 to 1)	(0) Disabled
Q77	Select Event Log (0 to 3)	(3) All Events
Q78	Select Output (00-12)	(11) Follows Internal Sounder Alarm‡
Q79	Select Z-Wave Feature (0 to 3)	(1) Disabled but Visible
Q80	Select Z-Wave Switches Feature (0 to 1)	(0) Disabled
Q81	Select Z-Wave Thermostats Feature (0 to 1)	(0) Disabled

Q#	Question	Default
Q82	Select Z-Wave Door Locks Feature (0 to 1)	(0) Disabled
Q83	Select Temperature Display Units (0 to 1)	(0) Degrees Fahrenheit
Q84	Select Services Require Master Code	(0) Disabled
Q85	Select Master User Access to Z-Wave Toolbox (0 to 1)	(0) Disabled
Q86	Select Disable Siren After Two-Way Audio (0 to 1)	(0) Disabled
Q87	Select Keyfob/Remote Arming Mode on System Not Ready (0 to 2)	(0) Auto-Bypass with Zone Participation on Restore
Q88	Select Z-Wave Siren Mode (0 to 1)	(0) Sound for Burglary and Fire/CO
Q89	Select Allow Backlight Always On (Demo Mode)	(0) Disabled
Q90	Select Energy Feature (0 to 2)	(0) Disabled and Hidden
Q91	Select Radio Modem Supplier	Varies by Supplier
Q92	Select Network Device (0 to 1)	(0) none
	Network Device ID (Read-Only)	0 NOTE: Only appears if (1) <i>Go!Bridge</i> is selected in Q92 <i>Select Network Device (0 to 1)</i>
	Select Port # (1 to 8)	(1) Port 1 NOTE: Typically, you will skip this question unless additional programming is required.
	Select Used (0 to 1)	(0) Disabled NOTE: Typically, you will skip this question unless additional programming is required.
	Enter Port Value (0-65535)	0 NOTE: Only appears if (1) <i>Enabled</i> is selected in <i>Select Used (0 to 1)</i>
	Enter Port Forward IP Address	000.000.000.000 NOTE: Only appears if (1) <i>Enabled</i> is selected in <i>Select Used (0 to 1)</i> . NOTE: Typically, you will accept the default IP address value that appears.
Q93	Enter Broadband Network Failure Time (1-255)	30
Q94	Select Broadband Network Failure Causes Trouble (0 to 1)	(1) Enabled
Q95	Select Broadband Network Failure Reports (0 to 1)	(1) Enabled

‡ Indicates the default setting for ANSI/SIA CP-01 compliance

* To comply with UL 985:Household Fire Warning System Units, the setting for Q46: *Select Trouble Doesn't Sound at Night* must be set to (0) *Disabled*.

SENSOR TYPES (ZONES)

Each sensor (wireless or wired) installed in the system is programmed to a specific sensor number and sensor type (zone).

The sensor number identifies the specific sensor when it is displayed on the Control Panel, recorded in the event log, or reported to the Central Station. This allows pin-point information about any sensor in the system.

The sensor type determines how and when the Control Panel responds to signals from the sensor. Some sensors are armed all the time, others are armed only in certain arming levels, some cause Central Station Reports anytime they are activated. The sensor's type, along with other programming options, determine this.

(00) Unused

This is the setting for unused sensor numbers that do not have a sensor programmed into them. No system action occurs at any time from this sensor type.

(01) Exit/Entry 1

This sensor type is reserved for doors that are used for exit and entry of the protected premises. When the system is armed in the **Stay** or **Away** mode, the exit delay timer starts. There is an exit delay regardless of whether the system is armed in **Stay** or **Away** mode. When the exit delay timer expires, the system is fully armed.

With the system fully armed, when this type of sensor is triggered, the *Entry Delay 1* timer starts. The system must be disarmed before the *Entry Delay 1* timer expires, or an alarm will occur.

If the entry delay timer is turned OFF during arming, the exit/entry delay sensors will act as non-delayed instant sensors at the end of exit delay.

(02) Exit/Entry 2

This sensor type operates the same as the *Exit/Entry 1* sensor type except it starts the *Entry Delay 2* timer. This provides a method of having a longer entry delay on certain openings, such as a garage door, to provide the end user more time to disarm the system.

(03) Perimeter

This sensor type is for perimeter doors and windows that will not be used to enter or exit the protected premises while the system is armed. An instant alarm will occur when this type of sensor is triggered with the system armed in either the **Stay** or **Away** mode.

(04) Interior Follower

This sensor type is for interior sensors such as motion detector, interior doors, and other sensors that detect human presence inside the protected premises. This type of sensor is called a "follower" due to its action when the system is armed in the **Away** mode. After the exit delay expires and the system is armed, if an interior follower sensor is triggered, an instant alarm will occur. If an exit/entry delay sensor is triggered first, the interior follower sensor will also be delayed.

Interior follower sensors are always bypassed and not active when the system is armed in **Stay** mode. This allows the premises to be occupied while still protecting the perimeter.

(05) Day Zone

This sensor type is the same as a perimeter zone, except when the system is disarmed, a violation displays a trouble alert on the Console's display. Common uses for this sensor type are protection of sensitive areas that require notification and possibly a Central Station trouble report, but not an alarm when the system is disarmed.

(06) 24-Hour Silent Alarm

This sensor type is active independent of the system arming status. The code for silent panic is sent to the Central Station, but for safety, there are no visual or audible indications locally that this sensor type has been triggered.

(07) 24-Hour Audible Alarm

This sensor type is continuously armed 24-hours a day. A sensor programmed to this type will trigger a local alarm and the bell output regardless of the mode the system is in. Typical use would be an audible panic alarm.

(08) 24-Hour Auxiliary Alarm

This sensor type is continuously armed 24-hours a day. A sensor programmed to this type will trigger an alarm regardless of the mode the system is in. The bell output will not activate, but the local sounder will continue until it's acknowledged at the Control Panel. Typical use would be for a monitoring device such as a flood or temperature sensor. There is no time out for the internal sounder, it will continue until a user code is entered.

(09) 24-Hour Fire †

This sensor type is continuously armed 24-hours a day. A sensor programmed to this type will trigger the local alarm fire sounder and the bell output regardless of the mode the system is in. Typical use would be for wireless smoke detectors. This sensor type is always active and cannot be bypassed.

(10) Interior with Delay

This sensor type operates as a delayed sensor when the system is armed in the **Away** mode, and when triggered, will start the *Entry Delay 1* timer. If the system is armed in **Away** mode with no *Entry Delay* (armed instant), this sensor type will trigger an instant alarm.

If the system is armed in **Stay** mode (or **Stay** mode with no **Entry Delay**), this sensor type will be bypassed.

(14) 24-Hour Carbon Monoxide †

This sensor type is continuously armed 24-hours a day. A sensor programmed to this type will trigger the local alarm pulse sounder and the bell output regardless of the mode the system is in. Typical use would be for wireless carbon monoxide detectors. This sensor type is always active and cannot be bypassed.

(16) 24-Hour Fire with Verification †

This sensor type is continuously armed 24-hours a day. A sensor programmed to this type can trigger the local alarm fire sounder and the bell output regardless of the mode the system is in. Typical use would be for wireless smoke detectors. This sensor type is always active and cannot be bypassed.

For verification, this sensor type must be violated twice in two (2) minutes, or remain violated for 30 seconds. If any other fire sensor (verified sensor type or not) violates within two minutes, both sensors will cause a fire alarm.

(23) No Response Type

This sensor type is a special zone that can be monitored for activity or inactivity by the Central Station. It does not affect security system status.

(24) Silent Burglary

This sensor type is for silent triggering the burglary alarm with perimeter doors and windows that will not be used to enter or exit the protected premises while the system is armed. The Control Panel's sounder and the bell output will not activate.

An instant silent alarm will occur when this type of sensor is triggered with the system armed in either the **Stay** or **Away** mode.

† Indicates Sensor types that are not allowed for hardwire loops.

VOICE DESCRIPTORS

The Control Panel includes a system vocabulary. When programming sensors when using firmware version 1.12, you can use the codes detailed in this table:

Figure 49 List of Voice Descriptors

Code Word	Code Word	Code Word	Code Word
002	ABORT	070	ENTRY
003	AC	071	ERROR
004	ACCESS	072	EXERCISE
005	ALARM	073	EXIT
006	AND	074	EXIT NOW
007	ANNOUNCEMENT	075	EXTERIOR
008	AREA	076	EXTERNAL
009	ARM	077	FAILURE
010	ARMED	078	FAMILY
011	ARMING	079	FAN
012	AT	080	FIFTEEN
013	ATTIC	081	FIFTY
014	AUDIO	082	FIRE
015	AUTO	083	FIRE ALERT
016	AUTOMATION	084	FIRE DETECTOR
017	AUXILIARY	085	FIRST
018	AWAY	086	FIVE
019	BABY'S	087	FLOOD
020	BACK	088	FLOOR
021	BASEMENT	089	FLUID
022	BATHROOM	090	FOIL
023	BATTERY	091	FOR
024	BEDROOM	092	FORTY
025	BONUS	093	FOUR
026	BREAK	094	FOURTEEN
027	BUTTON	095	FOURTH
028	BYPASS	096	FREEZE
029	BYPASSED	097	FREEZER
030	CABINET	098	FRONT
031	CANCEL	099	FURNACE
032	CARBON MONOXIDE	100	GAME
033	CELLAR	101	GARAGE
034	CELLULAR	102	GAS
035	CELL RADIO	103	GLASS
036	CENTER	104	GLASS BREAK
037	CHECK	105	GUEST
038	CHEST	106	GUN
039	CHILDREN'T	107	HALL
040	CHIME	108	HALLWAY
041	CLOSET	109	HANGING
042	CODE	110	HANG UP
043	COMMUNICATIONS	111	HEAT
044	COMPUTER	112	HIGH
045	CONTROL	113	HOME
046	COOL	114	HOUSE
047	CRAWL	115	ICE
048	CURRENT	116	INSIDE
049	DAY	117	INSTANT
050	DEGREES	118	INTERIOR
051	DEN	119	INTRUSION
052	DETECTOR	120	IS
053	DIM	121	KEY
054	DINING	122	KEYFOB
055	DISARM	123	KEYPAD
056	DISARMED	124	KIDS
057	DOCK	125	KITCHEN
058	DOOR	126	LAUNDRY
059	DOWNSTAIRS	127	LEFT
060	DRIVEWAY	128	LEVEL
061	EAST	129	LIBRARY
062	EIGHT	130	LIGHT
063	EIGHTEEN	131	LIGHTS
064	EIGHTY	132	LIQUOR
065	ELECTRIC	133	LIVING
066	ELEVEN	134	LOADING
067	EMERGENCY	136	LOCK
068	ENTER	136	LOFT
069	ENTRANCE	137	LOW
#	WORD	#	WORD
138	MAIN	206	SKYLIGHT
139	MAINTENANCE	207	SLIDING
140	MASTER	208	SMOKE
141	MEDICAL	209	SOUNDER
142	MEDICINE	210	SOUTH
143	MENU	221	SPACE
144	MIDDLE	212	SPARE
145	MONITOR	213	STAIRS
146	MOTION	214	STAR
147	MOTION DETECTOR	215	STATUS
148	MUD	216	STAY
149	NINE	217	STOP
150	NINETEEN	218	STORAGE
151	NINETY	219	STUDY
152	NORTH	220	SUMP
153	NOT	221	SUPERVISION
154	NOT READY	222	SYSTEM
155	NO DELAY	223	TAMPER
156	NO ENTRY DELAY	224	TEMPERATURE
157	NURSERY	225	TEN
158	OFF	226	TERMINATED
159	OFFICE	227	THERMOSTAT
160	ON	228	THIRD
161	ONE	229	THIRTEEN
162	ONE HUNDRED	230	THIRTY
163	OUTPUT	231	THREE
164	OUTSIDE	232	TO
165	PANEL	233	TOOL
166	PANIC	234	TRANSMITTED
167	PANTRY	235	TRANSMITTER
168	PATIO	236	TROUBLE
169	PERIMETER	237	TURN
170	PHONE LINE	238	TWELVE
171	PLAY	239	TWENTY
172	POLICE	240	TWO
173	POOL	241	UNLOCK
174	POUND	242	UPPER
175	POWER	243	UPSTAIRS
176	PRESS	244	USER
177	PREVIOUS	245	UTILITY
178	PUMP	246	VALVE
179	RADIO	247	VOICE
180	READY	248	WALL
181	REAR	249	WATER
182	RELAY	250	WEST
183	REMOTE	251	WINDOW
184	REPEAT	252	WIRELESS
185	RF JAM	253	YARD
186	RIGHT	254	ZERO
187	ROOM	255	ZONE
188	SAFE	256	BALCONY
189	SECOND	257	COURTYARD
190	SECURITY	258	DECK
191	SENSOR	259	DETACHED
192	SENSORS	260	OVERHEAD
193	SESSION	261	REFRIGERATOR

Code Word	Code Word
194 SET	262 SERVICE
195 SEVEN	263 SUNROOM
196 SEVENTEEN	264 WAREHOUSE
197 SEVENTY	265 GATE
198 SHED	266 APARTMENT
199 SHOP	267 FOYER
200 SIDE	268 TV
201 SILENT	269 VIDEO
202 SIREN	270 PORCH
203 SIX	271 CORNER
204 SIXTEEN	
205 SIXTY	

EQUIPMENT CODES

The table below details the available equipment codes in firmware version 1.12.

Code	Equipment
(0000)	Other
(0862)	DW10-345Thin Door/Window Contact
(0863)	DW20R-345 Recessed Door Contact
(0869)	PIR1-345 PIR with Pet Immunity
(0864)	GB1-345 Glass break detector
(0895)	SMTK2-345 GE Smoke/Heat detector (USA/Canada)
(1058)	SMTK3-345 2GIG Smoke Detector
(0872)	SMKE1-345 Smoke Detector (USA)
(0871)	SMKE1-345C Smoke Detector (Canada)
(0868)	PANIC1-345 Panic Button Remote
(0860)	CO1-345 CO Detector (USA)
(0859)	CO1-345 CO Detector (Canada)
(1026)	CO3-345 2GIG CO Detector (USA/Canada)
(0873)	TAKE-345 Takeover Module
(0637)	HWD/W"5816"
(0470)	HW R-D/W "5818MNL"
(0533)	HW PIR "5890"
(0530)	HW PIR "5894Pi"
(0519)	HW Glass Break "5853"
(0589)	HW Smoke "5808W3"
(0557)	HW Heat Sensor "5809"
(0624)	HW Flood Sensor "5821"
(0491)	HW Panic Pendant "5802MN2"
(0655)	Existing Door/Window Contact
(0609)	Existing Motion Detector
(0475)	Existing Glass Break Detector
(0616)	Existing Smoke Detector
(0692)	Existing CO Detector
(0708)	Existing Heat Sensor
(0556)	Existing Flood/Temp Sensor
(1061)	Garage01 Resolution Products Tilt Sensor
(1063)	DBELL1-345 2GIG Doorbell
(9999)	Alarm.com Image Sensor

INSTALLER PROGRAMMING

ACCOUNT REGISTRATION

The account registration process is used to enroll the Control Panel with remote service provider's Central Station.

Typically, the account registration data is created with the service installation contract and then stored in a database managed by the Central Station. The data includes items such as the customer name, address, and the Central Station telephone number and account number assigned to the Control Panel.

If you will be installing the 2GIG Go!Bridge IP Communicator, additional registration information required. For details, see the *Installation Instructions* included with the Go!Bridge IP Communicator.

WIRELESS (RF) SENSOR PROGRAMMING

The Control Panel can be programmed with up to 48 RF sensors of different types. In addition to the 48 multi-purpose RF sensors, you can also program eight (8) RF remote control key fobs and four (4) RF remote control keypads into the system.

RF sensors # 01-48 report as system sensors 01-48.

Programming questions for RF sensor programming include:

- **Q1: Select RF Sensor Number.** Select sensor number 01-48.
- **Q: Select RF Sensor # Type.** Select (01) Exit/Entry 1, (02) Exit/Entry 2, (03) Perimeter, and so on. For options, see "Sensor Types (Zones)" on page 36.
- **Q: Select RF Sensor # Equipment Type.** Some sensor types ask for the equipment type, others do not. See "Q: Select RF Sensor # Equipment Type" on page 43.
- **Q: Select RF Sensor # Equipment Code.** Select the four (4)-digit equipment code for the sensor model. See "Equipment Codes" on page 40.
- **Q: Select RF Sensor # Other Equipment Code.** If you select (0000) Other in the previous question, you must enter this code.
- **Q: Enter RF Sensor # Serial #.** Enter the serial number (typically a label on the sensor or its packaging) or press **Shift** then **Learn** on the panel. Then trip the sensor to transmit the serial number to the panel.
- **Q: Select RF Sensor # Equipment Age.** Specify whether the sensor is (0) New or (1) Existing.
- **Q: Select RF Sensor # Loop Number.** Specify the appropriate loop number(s) for the sensor. See "Q: Select RF Sensor # Loop Number (1 to 3)" on page 44.
- **Q: Select RF Sensor # Dialer Delay.** Delayed or instant digital communicator reports for the sensor. The delay time is set using the Dialer Abort screen.
- **Q: Construct RF Sensor # Voice Descriptor.** Name assigned to the sensor and announced if programmed.
- **Q: Select RF Sensor # Reports.** Specify (0) Disabled or (1) Enabled whether RF sensors trigger a report to the Central Station or not.

- **Q: Select RF Sensor # Supervised.** Control Panel checks for status reports from the sensor, or does not check for status reports]
- **Q: RF Sensor # Chime.** Select voice announcement and chime options for the sensor.

Q1: RF Sensor Programming Outline

Figure 50 RF Sensor Programming Outline

Q1: RF Sensor Programming Outline

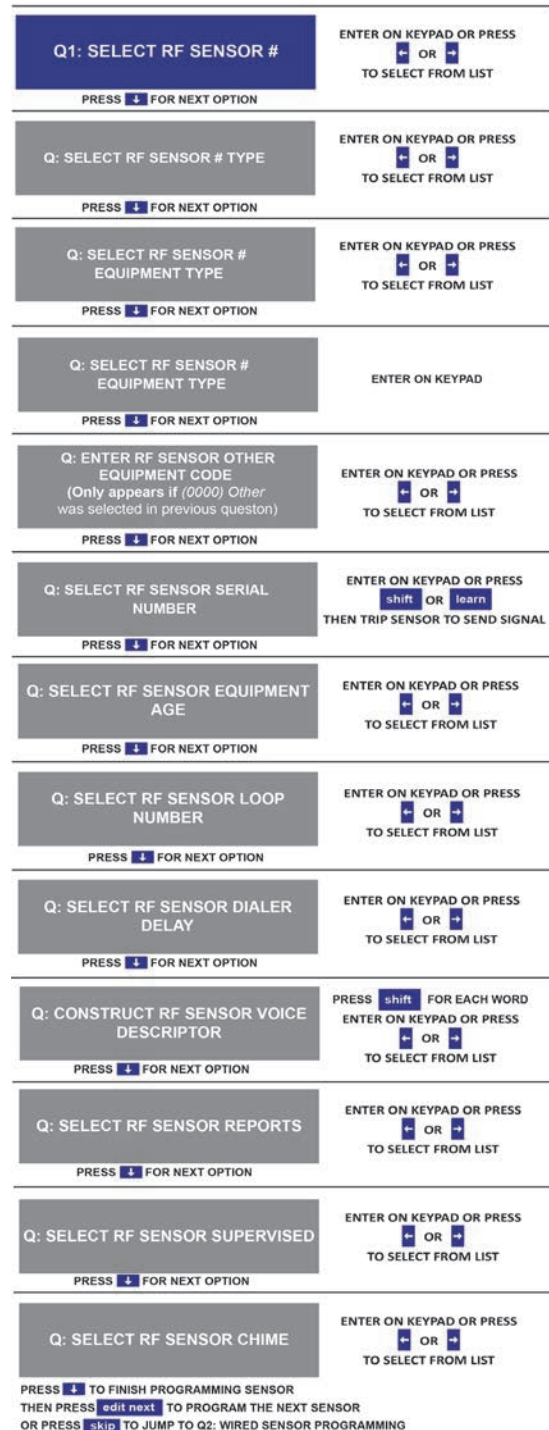

Scroll between options using the ← and → arrows. Move to the previous or next prompt by pressing the ↑ and ↓ arrows.

- 1 To program another sensor click **Next**.
- 2 To exit programming, click **Skip** then **End** and **Exit**. Upon exit, the panel takes several seconds to restart.

*Only used for “other” equipment

Press **Insert for each word. To select from the list, you can use the keypad or press the ← or → arrows.

Summary of RF Sensor # Screen

After setting all the options for a sensor, the RF sensor summary screen is displayed. The screen can also be displayed for programmed sensors during RF sensor program editing by pressing the **Sum** button.

- While programming each RF sensor remember that the ← and → arrow buttons step through each of the RF sensor numbers.
- To return to programming, click the **Edit Current** or **Edit Next** buttons.
- Pressing **Skip** goes to question number Q2 (Wired Sensor Programming). See “*Wired Sensor Programming*” on page 45.

Figure 51 Summary of RF Sensor # Screen



RF Sensor Programming Questions

Q1: Select RF Sensor # (01-48)

Up to 48 wireless RF sensors can be used with each Control Panel. The options for each sensor are programmed with sub-option questions.

- 1 Enter the RF sensor number or press the ← or → arrows to select it.
- 2 Program the sensor details by using the ↑ and ↓ arrows to select each of the sub-options.

NOTE: To skip Q1 and jump directly to Q2 for Wired Sensor Programming, press **Skip**.

Q: Select RF Sensor # Type

DEFAULT: (00) Unused

Answer this question to define the sensor type (zone). Simply enter the appropriate code (see table below) or press the ← or → arrows to select the desired zone.

In the table below, a “Y” indicates the sensor type can be assigned. A “N” indicates the sensor type is not used, and an asterisk (*) denotes that selecting this sensor type also requires you to answer the *Q: Select RF Sensor # Equipment Type* question.

Sensor Types (Zones)	RF	Wired
(00) Unused	Y	Y
(01) Exit/Entry 1	Y	Y
(02) Exit/Entry 2	Y	Y
(03) Perimeter	Y	Y
(04) Interior Follower*	Y	Y
(05) Day Zone	Y	Y
(06) 24-Hour Silent Alarm*	Y	Y
(07) 24-Hour Audible Alarm*	Y	Y
(08) 24-Hour Auxiliary Alarm*	Y	Y
(09) 24-Hour Fire	Y	N
(10) Interior with Delay*	Y	Y
(14) 24-Hour Carbon Monoxide	Y	N
(16) 24-Hour Fire Verification	Y	N
(23) No Response Type*	Y	Y
(24) Silent Burglary	Y	Y

Q: Select RF Sensor # Equipment Type

DEFAULT: Varies by RF Sensor Type

NOTE: Some sensor types (zones) will require you to specify an equipment type selection, which affects the sensor's extended reporting code.

Simply enter the appropriate equipment type code (see table below) or press the ← or → arrows to select the appropriate equipment type.

The table below shows the Equipment Types available for each Sensor Type (Zone):

Sensor Type (Zone)	Equipment Types
(04) Interior Follower	(1) Motion (2) Contact
(06) 24-Hour Silent Alarm	(1) Contact (11) Emergency
(07) 24-hour Audible Alarm	(1) Contact (11) Emergency
(08) 24-Hour Auxiliary	(1) Contact (6) Freeze (8) Water (10) Temperature (11) Emergency
(10) Interior with Delay	(1) Motion (2) Contact
(23) No Response Type	(1) Contact (2) Motion

Q: Select RF Sensor # Equipment Code

DEFAULT: (0000) Other

Select the four (4)-digit equipment code that corresponds to the appropriate sensor model. See "Equipment Codes" on page 40.

Q: Select RF Sensor # Other Equipment Code

NOTE: This sub-question is only displayed if (0000) Other is selected as the RF Sensor # Equipment Code.

Enter the equipment code number directly on the keypad for the RF sensor. Enter "0" if the new equipment code is unknown.

Q: Enter RF Sensor # Serial Number (7 Digits)

DEFAULT: 0000000

RF sensor serial numbers can be manually entered or automatically transmitted from the sensor to the Control Panel.

- **For manual entry.** Enter the sensor number that was logged for the sensor being programmed. Press **Shift** to access alphabetic characters.
- **For automatic entry.** Press **Shift**, then press **Learn** to place the Control Panel into learning mode. Then trigger the RF sensor. The Control Panel will beep four (4) times and learn the sensor's serial number.

If the sensor being learned is already in memory, the Control Panel will display a sensor learning failure screen when the programming changes are being saved.

For certain sensors with more than two loops, the tamper switch must be used to send a signal to the Control Panel during sensor learning. First press of tamper switch will learn as Loop #1, the second press of tamper switch will learn as Loop #2, the third press of tamper switch will learn as Loop #3.

Wait 15 seconds between each press of the tamper switch.

The programmed loop number of the sensor in the Control Panel may need changing to suit the operation of the device. For details, see the *Install Instructions* for the sensor.

Q: Select RF Sensor # Equipment Age (0 to 1)

DEFAULT: (0) New

The Control Panel can be used with new or existing RF sensors.

- If this RF sensor is new for the installation, leave the default setting of (0) *New*.
- If this RF sensor is already installed, select (1) *Existing*.

NOTE: If the RF sensor has more than one loop and is being programmed into multiple sensor numbers to support the loops, set only one loop as "new" and the other loops as "existing". This will prevent incorrect inventory of the installed sensors.

Q: Select RF Sensor # Loop Number (1 to 3)**DEFAULT: Varies with sensor model selected**

The 2GIG Door/Window Contact sensors have two (2) inputs: an internal magnetic contact and an external *Normally Closed* (N/C) hardwire input. Either or both sensor inputs can be used.

TIP: Some sensors are capable of three (3) loop inputs.

NOTE: When using both the internal magnetic contact and the external input, the magnet contact AND the external contact must be assigned a different RF sensor number. Both sensor numbers will share the same sensor serial number.

- When programming the sensor to use the built-in magnetic contact, set the loop number to (2).
- When programming the sensor to use its hardwire input, set the loop number as (1).
- When programming a three (3)-loop sensor to use an additional input, set the loop number as (3).
- When entering the sensor number for the sensor's loop 2 or 3, the **Paste** button can be used to recall the last programmed sensor's serial number. (The sensor number will be filled in automatically if **Learn** is used.)

Q: Select RF Sensor # Dialer Delay (0 to 1)**DEFAULT: (1) Enabled**

If this feature is enabled, the delay time must be set to a minimum of 30 seconds for ANSI/SIA compliance. To set the delay time, see "Q35: Abort Window Dialer Delay (0-2)" on page 58.

- RF sensors can trigger the digital communicator immediately or after a delay. The default setting (1) *Enabled* causes delayed dialing for this RF sensor number.
- For immediate dialing for this RF sensor number, select (0) *Disabled*.

NOTE: This setting for CO and Smoke Alarms is automatically set to (0) *Disabled*, and this sub-question is skipped for these sensor types.

Q: Construct RF Sensor # Voice Descriptor**DEFAULT: No Default**

NOTE: For a list of available voice descriptors, see "Voice Descriptors" on page 38.

The voice descriptors are the words the Control Panel will announce for this RF sensor if this sensor is programmed for voice annunciation. Up to five(5) words are allowed.

- 1 Press **Insert** to place a word from the vocabulary into the data entry field.
- 2 Press the ← or → arrows to scroll through the words, or enter the word's three (3)-digit index number.
- 3 Press **Insert** again for the next word. Up to five words are allowed.
- 4 To move between words, press the **Fwd** and **Back** buttons.

To remove a word, press **Delete**.

Q: Select RF Sensor # Reports (0 to 1)**DEFAULT: (1) Enabled**

RF sensors can be programmed to trigger a report to the Central Station or not.

- The default setting (1) *Enabled* enables reporting for this RF sensor number.
- To prevent reporting for this RF sensor number, select (0) *Disabled*.

Q: Select RF Sensor # Supervised (0 to 1)**DEFAULT: (1) Enabled**

When a sensor is set to supervised, the Control Panel will expect regular timed signals from this sensor or else a sensor supervisory trouble alert will occur.

- The default setting (1) *Enabled* allows supervision for this RF sensor.
- To turn off supervision for this RF sensor, select (0) *Disabled*.

NOTE: Portable sensors such as panic buttons should not be set as supervised if the sensor will be removed from the premises at times.

Q: Select RF Sensor# Chime (00 to 13)**DEFAULT: (0) Disabled**

Each RF sensor can be set to sound a "ding-dong" chime and/or sound its voice descriptor when the sensor is triggered. This step determines the initial setting for the sensor.

The end user can change the chime setting for sensors using **Chime Setup** in the User Toolbox.

- The default setting (0) *Disabled* disables the chime for this RF sensor.
- If a chime and/or voice is required for this RF sensor, choose one of the other chime options:

Code	Sensor Chime
(0)	Disabled
(1)	Voice Only
(2)	Ding-Dong with Voice #1
(3)	Ding-Dong #2
(4)	Ding-Dong with Voice #2
(5)	Ding-Dong #1
(6)	Ding-Ding
(7)	Ding-Ding with Voice
(8)	Ding-Dong #3
(9)	Ding-Dong with Voice #3
(10)	Chime #1
(11)	Chime #1 with Voice #1
(12)	Chime #2
(13)	Chime #2 with Voice #2

WIRED SENSOR PROGRAMMING

The Control Panel can be programmed with up to two (2) wired sensors. The wired sensors are hardwire contact loops connected to the loop input terminals on the Control Panel's terminal strip. To see where the two (2) hardwire sensors can be wired into the Terminal Block, see the "Terminal Block Wiring Diagram" on page 20.

CAUTION: Wired sensors cannot be used for a CO or Fire sensor loop.

IMPORTANT: Note that Wired Sensor reports as below:

- Wired Sensor #1 = Reports as Sensor #49
- Wired Sensor #2 = Reports as Sensor #50

See Figure 52 "Wired Sensor Programming Outline" on page 45 on the next page for the steps required to program wired sensors into the Control Panel. The options that can be set for each wired sensor are:

- **Q2: Wired Sensor Number.** Select 1 or 2.
- **Q: Wired Sensor # Type.** Select the zone. For example, (01) Exit/Entry 1, (02) Exit/Entry 2, (03) Perimeter, and so on. See "Sensor Types (Zones)" on page 36.
- **Q: Wired Sensor # Equipment Type.** Some sensor type (zones) will prompt you to specify the equipment type. Other sensor types will not prompt you for an equipment type.
- **Q: Wired Sensor # Equipment Code.** Select the four (4)-digit equipment code that corresponds to the appropriate sensor model. See "Equipment Codes" on page 40
- **Q: Wired Sensor # Equipment Age.** Specify whether the sensor is a (0) New or (1) Existing.
- **Q: Wired Sensor # Normal State.** Choose between (0) Not Used, (1) Closed, (2) Open, (3) End-Of-Line-Resistor.
- **Q: Wired Sensor # Dialer Delay.** Delayed or instant digital communicator reports for the sensor. The delay time is set by Dialer Abort screen.
- **Q: Wired Sensor # Voice Descriptor.** Name assigned to the sensor and announced if programmed.
- **Q: Wired Sensor # Reports.** Send or do not set digital communicator reports for the sensor.
- **Q: Wired Sensor # Chime.** Select voice announcement and chime options for the sensor.

Q2: Wired Sensor Programming Outline

Figure 52 Wired Sensor Programming Outline

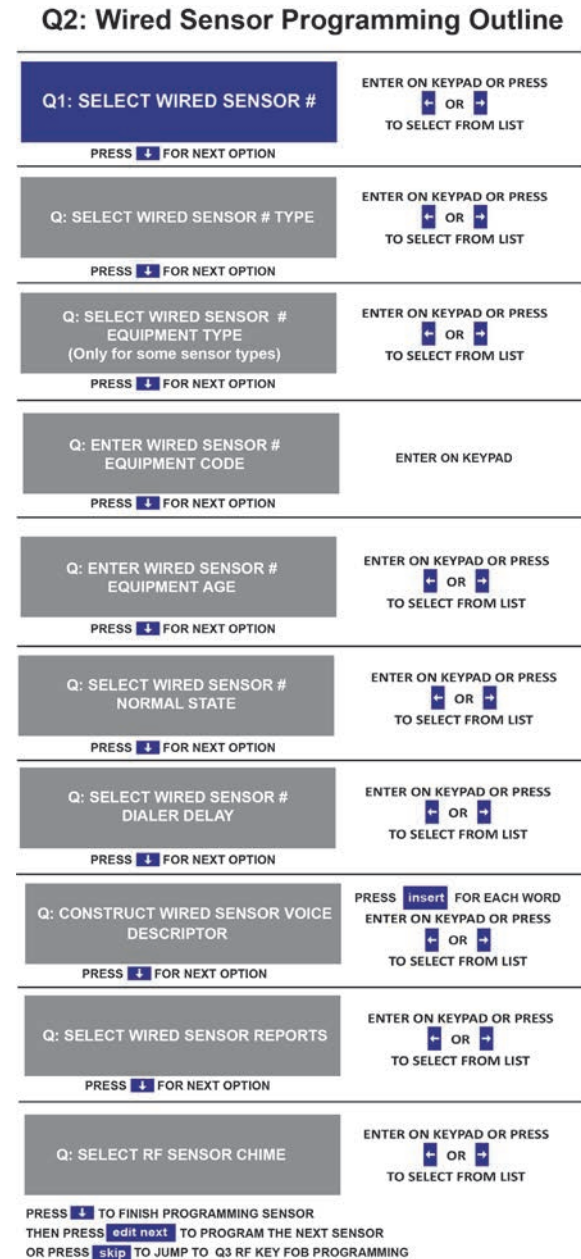

Scroll between options using the ← and → arrows. Move to the previous or next prompt by pressing the ↑ and ↓ arrows.

- 1 To program another sensor click **Next**.
- 2 To exit programming, click **Skip** then **End** and **Exit**. Upon exit, the panel takes several seconds to restart.

Summary of Wired Sensor # Screen

After setting all the options for a sensor, the wired sensor summary screen is displayed. The screen can also be displayed for programmed sensors during wired sensor program editing by pressing the **Sum** button.

- While programming each wired sensor remember that the ← and → arrow buttons step through each of the wired sensor numbers.
- To return to programming, click the **Edit Current** or **Edit Next** buttons.
- Pressing **Skip** goes to question number Q3 (RF Key Fob Programming). See "Wireless (RF) Key Fob Programming" on page 48.

Figure 53 Summary of Wired Sensor # Screen



NOTE: For the detailed steps of programming a wired sensor, see "Wired Sensor Programming Questions" on page 46.

Wired Sensor Programming Questions

Q2: Select Wired Sensor # (1-2)

Two hardware loops can be used as sensors with each Control Panel. The options for each wired sensor are programmed with sub-option questions.

- Begin by entering the wired sensor number or select it using the ← or → arrows.
- After selecting the wired sensor number, program the wired sensor details by using the ↑ and ↓ arrows to select each of the sub-options.

NOTE: To skip wired sensor programming, press **Skip** to jump from question Q2 to question Q3. See "Wireless (RF) Key Fob Programming" on page 48.

Q: Select Wired Sensor# Type

DEFAULT: (00) Unused

Each wired sensor needs to be assigned to a sensor type.

Select the sensor type that matches the wired sensor's function using the ← or → arrows or enter the sensor type number directly on the keypad.

In the table below, a "YES" indicates the sensor type can be used for the wired sensor. An "NO" indicates the sensor type is not used.

Sensor Types (Zones)	RF Sensors	Wired Sensors
(00) Unused	Yes	Yes
(01) Exit/Entry 1	Yes	Yes
(02) Exit/Entry 2	Yes	Yes
(03) Perimeter	Yes	Yes
(04) Interior Follower	Yes	Yes
(05) Day Zone	Yes	Yes
(06) 24-Hour Silent Alarm	Yes	Yes

Sensor Types (Zones)	RF Sensors	Wired Sensors
(07) 24-Hour Audible Alarm	Yes	Yes
(08) 24-Hour Auxiliary Alarm	Yes	Yes
(09) 24-Hour Fire	Yes	No
(10) Interior with Delay	Yes	Yes
(14) 24-Hour Carbon Monoxide	Yes	No

Q: Select Wired Sensor# Equipment Type

DEFAULT: Varies by wired sensor type

This question is only displayed when certain sensor types are selected.

The equipment type selection will affect the sensor's extended reporting code.

The following sensor types require equipment type selection:

Sensor Type	Equipment Types Available
(04) Interior Follower	(1)=motion (2)=contact
(06) 24-Hour Silent Alarm	(1)=contact (11)=emergency
(07) 24-Hour Audible Alarm	(1)=contact (11)=emergency
(08) 24-Hour Auxiliary	(1)=contact (6)=freeze (8)=water (10)=temperature (11)=emergency
(10) Interior with Delay	(1)=motion (2)=contact
(23) No Response Type	(1)=contact (2)=motion

- Select the equipment type that matches the sensor equipment using the ← or → arrows, or enter the equipment type number directly on the keypad.

NOTE: This Control Panel does not provide auxiliary accessory output power.

Connecting a hardwire PIR using equipment type "motion" will require an external stand-alone battery backed-up power supply for the PIR.

Q: Select Wired Sensor# Equipment Code (0-9999)

DEFAULT: (0)

Select the four (4)-digit equipment code that corresponds to the appropriate sensor model. See "Equipment Codes" on page 40.

Q: Select Wired Sensor# Equipment Age (0 to 1)

DEFAULT: (0) New

The Control Panel can be used with new or existing wired sensors.

- If this wired sensor is new for the installation, leave the default setting of (0) *New*.
- If this wired sensor is already installed, select (1) *Existing*.

Q: Select Wired Sensor# Normal State

DEFAULT: (0) Not Used

The two hardware loops can be wired for normally open (N/O) or normally closed (N/C) contacts, or for end-of-line (EOL) resistor.

- The default setting (0) *Not Used* disables this wired sensor.
- To use this wired sensor, select the way the loop is wired:

Wired Sensor Normal State

- (0) *Not Used*
- (1) *Closed*
- (2) *Open*
- (3) *End-of-Line Resistor*

Q: Select Wired Sensor# Dialer Delay (0 to 1)

DEFAULT: (1) Enabled

If this feature is enabled, the delay time must be set to a minimum of 30 seconds for ANSI/SIA compliance. To set the delay time, see "Q35: Abort Window Dialer Delay (0-2)" on page 58.

Wired sensors can trigger the digital communicator immediately or after a delay.

- The default setting (1) *Enabled* causes delayed dialing for this wired sensor number.
- For immediate dialing for this wired sensor number, select (0) *Disabled*.

Q: Construct Wired Sensor # Voice Descriptor

DEFAULT: No Default

NOTE: For a list of voice descriptors, see "*Voice Descriptors*" on page 38.

The voice descriptors are the words the Control Panel will announce for this wired sensor if this wired sensor is programmed for voice annunciation. Up to five words are allowed.

- 1 Press **Insert** to place a word from the vocabulary into the data entry field.
- 2 Use the ← or → arrows to scroll through the words, or enter the word's three (3)-digit number.
- 3 Press **Insert** again for the next word. Up to five words are allowed.
- 4 To move between words, press the **Fwd** and **Back** buttons.
- 5 To remove a word, press **Delete**.

Q: Select Wired Sensor# Reports (0 to 1)

DEFAULT: (1) Enabled

Wired sensors can be programmed to trigger a report to the Central Station or not.

- The default setting (1) *Enabled* activates reporting for this wired sensor number.
- To prevent reporting for this wired sensor number, select (0) *Disabled*.

Q: Select Wired Sensor# Chime (00 to 13)

DEFAULT: (0) Disabled

Each wired sensor can be set to sound a "ding-dong" chime and/or sound its

voice descriptor when the sensor is triggered.

- The default setting (0) *Disabled* inactivates the chime for this wired sensor.
- If a chime and/or voice is required for this wired sensor, choose one of the other chime options:

Sensor Chime

Code	Sensor Chime
(0)	Disabled
(1)	Voice Only
(2)	Ding-Dong with Voice #1
(3)	Ding-Dong #2
(4)	Ding-Dong with Voice #2
(5)	Ding-Dong #1
(6)	Ding-Ding
(7)	Ding-Ding with Voice
(8)	Ding-Dong #3
(9)	Ding-Dong with Voice #3
(10)	Chime #1
(11)	Chime #1 with Voice #1
(12)	Chime #2
(13)	Chime #2 with Voice #2

WIRELESS (RF) KEY FOB PROGRAMMING

The Control Panel can be programmed with up to eight (8) RF key fobs.

Programming the fobs into the Control Panel involves selecting the sensor number for a particular device, setting or learning the serial number, and selecting the other options for the sensor.

IMPORTANT: RF key fobs 1 - 8 report to the Control Panel as sensors 51 - 58 (opening/closing, emergency, and low battery reports).

Fob #	Reports as Sensor #
1	51
2	52
3	53
4	54
5	55
6	56
7	57
8	58

See *Figure 54 Key Fob Programming Outline* for the steps required to program fobs into the Control Panel. The options that can be set for each fob are:

- **Q3: Select Fob Number.** Select key fob number 1-8.
 - **Q: Select Fob # Used.** Select (0) Disabled or (1) Enabled.
 - **Q: Select Fob # Equipment Code.** Select the four (4)-digit equipment code that corresponds to the appropriate keyfob. See "Equipment Codes" on page 40.
 - **Q: Enter Fob # Other Equipment Code.** Enter the special equipment code. This is only required when the **Key Fob # Equipment Code** is set to (0000) Other.
 - **Q: Enter Fob # Serial #.** Enter the serial number (typically a label on the sensor or the sensor packaging) or press **Shift** then **Learn** to place the panel into learning mode. Then trip the sensor to transmit the serial number to the panel.
 - **Q: Select Fob # Equipment Age.** Specify whether the sensor is a (0) New or (1) Existing sensor.
 - **Q: Select Fob # Emergency Key.** Choose the function of double-pressing the top buttons (0) Disabled, (1) Auxiliary Alarm, (2) Audible Alarm, (3) Silent Panic, or (4) Fire.
 - **Q: Select Fob # Key # Can Disarm.** Choose (0) Disabled or (1) Enabled to specify if the key fob is allowed to disarm the system.
 - **Q: Construct Fob # Voice Descriptor.** Construct the name assigned for the sensor announcement. See "Voice Descriptors" on page 38.
 - **Q: Select Fob # Arm No Delay.** Choose if keyfob will arm instantly without an exit delay.
 - **Q: Select Fob # Key # Output.** Select action for key fob auxiliary button.

Key Fob Programming Outline

Figure 54 Key Fob Programming Outline

Q3: RF Key Fob Programming Outline

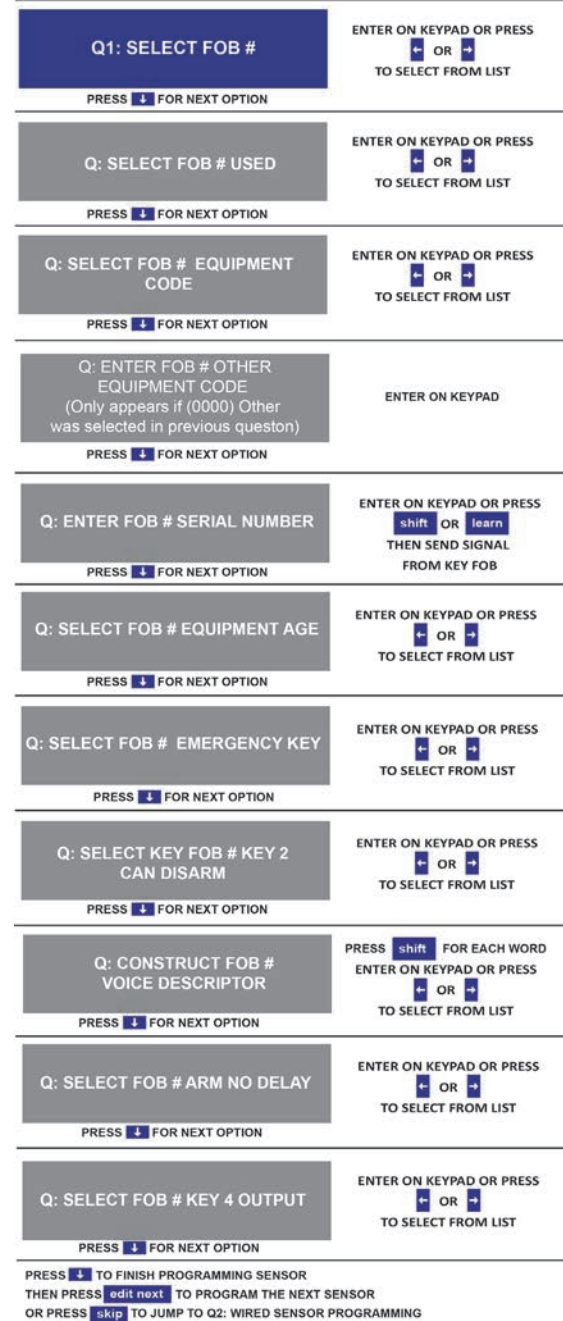

Scroll between options using the **←** and **→** arrows. Move to the previous or next prompt by pressing the **↑** and **↓** arrows.

- 1 To program another sensor click **Next**.
- 2 To exit programming, click **Skip**, then **End**, and then **Exit**. Upon exit, the panel takes several seconds to restart.

TIP: Press **Skip** to jump to question Q4. See "RF Keypad Programming Questions" on page 52.

Summary of RF Key Fob # Screen

After setting all the options for a key fob, the **Summary of Fob #** screen is displayed. The screen can also be displayed for programmed sensors during wired sensor program editing by pressing the **Sum** button.

- While programming each key fob remember that the ← and → arrow buttons step through each of the key fob numbers.
- To return to programming, click the **Edit Current** or **Edit Next** buttons.
- Pressing **Skip** goes to question number Q4 (RF Keypad Programming). See "Wireless (RF) Keypad Programming" on page 51.

RF Key Fob Programming Questions

Q3: Select Fob # (1 to 8)

Up to eight (8) wireless four (4)-button key fobs can be used with each Control Panel. Key fobs reports as sensors 51-58. The options for each fob are programmed with sub-option questions.

- Begin by entering the fob number or select it using the ← or → arrows.
- Program the key fobs by using ↑ and ↓ arrows to select the sub-options.

NOTE: To skip RF key fob programming, press **Skip** to jump from question Q3 to question Q4 (RF keypad programming). See "RF Keypad Programming Questions" on page 52.

Q: Select Fob # Used (0 to 1)

DEFAULT: (0) Unused

Key fobs can be used with the Control Panel or not.

- The default setting (0) *Unused* sets all key fobs as unused.
- To enable programming for this key fob, select (1) *Used*.

Q: Select Key Fob # Equipment Code (0-9999)

DEFAULT: (0000) Other

The key fob equipment code defines the sensor's manufacturer and type.

- The default setting is (0000) *Other*.
- Select (0866) *2GIG 4-button Key Fob* remote for a 2GIG-KEY2 key fob remote.
- Select (0577) *Existing Key Fob* remote for an existing key fob remote.

NOTE: Only 2GIG 4-Button Key Fob Remotes are compatible with this system.

Q: Enter Key Fob # Other Equipment Code (0-9999)

DEFAULT: 0

NOTE: This question is only displayed if (0000) *Other* is selected for a key fob's equipment code.

- The equipment code is a four (4)-digit code that is assigned to the model of key fob being used.
- Enter the equipment code number for the key fob.

Q: Enter Fob # Serial Number(7 Digits)

DEFAULT: 0000000

Key fob serial numbers can be manually entered or learned from the fob.

- For manual entry, enter the fob number that was logged for the fob being programmed. Use the **Shift** button to access alpha characters.
- For automatic entry, press **Shift**, then press **Learn**. The Control Panel will wait for a fob transmission. Trigger the fob being programmed and the Control Panel will learn the fob's serial number.

Q: Select Fob # Equipment Age (0 to 1)



DEFAULT: (0) New

The Control Panel can be used with new or existing key fobs.

- If this fob is new for the installation, leave the default setting of (0) *New*.
- If this fob is already installed, select (1) *Existing*.

Q: Select Fob # Emergency Key (0 to 4)

DEFAULT: (0) Disabled

Pressing the  and  buttons on a key fob at the same time for 5 seconds can trigger an emergency alarm.

- The default setting (0) *Disabled* inactivates the emergency function the fob #.
- To enable the emergency function for this fob, select one (1) of the four (4) options:
 - (1) *Auxiliary Alarm*
 - (2) *Audible Alarm*
 - (3) *Silent Panic*
 - (4) *Fire*

Q: Select Fob# Key # Can Disarm (0 to 1)

DEFAULT: (1) Enabled

As an installer, consult the user as to whether to set the key fob to allow disarming the Control Panel with the key fob's  button. If the user wants the key fob used as a stationary wall fob, it can also be set to prevent using the key fob to disarm the system.

- The default setting (1) *Enabled* allows the fob to disarm the system.
- To not allow the fob to disarm the system, select (0) *Disabled*.

Q: Construct Fob# Voice Descriptor

DEFAULT: (#) Keyfob

The voice descriptor are the actual the words that the Control Panel use for this fob for low battery *announcements* and log entries. Up to five (5) words are allowed.

- 1 Press **Insert** to place a word from the vocabulary into the data entry field.
- 2 Use the ← or → arrows to scroll through the words, or enter the word's three (3)-digit index number.
- 3 Press **Insert** again for the next word. Up to five words are allowed.
- 4 To remove a word, press **Delete**.

Q: Select Fob (#) Arm No Delay (0 to 1)

DEFAULT: (0) Disabled

Key fobs can be set to arm the Control Panel with or without an entry delay.

- The default setting *(0) Disabled* sets this fob to arm the system *with* an entry delay.
 - To set this fob to arm the system without an entry delay, select *(1) Enabled*.
-

Q: Select Fob# Key 4 Output (0-2)

DEFAULT: (0) Disabled

The key fob's ✖ auxiliary button can be used to trigger the Control Panel's open collector output.

The default setting *(0) Disabled* deactivates the fob's auxiliary button.

To use this fob's auxiliary button, select the output function:

- *(0) Disabled*
 - *(1) Toggle Output*
 - *(2) Momentary Output*
-

WIRELESS (RF) KEYPAD PROGRAMMING

The Control Panel can be programmed with up to four (4) RF keypads or RF touch screen keypads.

NOTE: RF Keypads 1 - 4 report to the Control Panel as sensors 59 - 62 (for emergency, and low battery reports).

RF Keypad Reporting Codes

Keypad 1	Reports as sensor #59
Keypad 2	Reports as sensor #60
Keypad 3	Reports as sensor #61
Keypad 4	Reports as sensor #62

- User Codes #1 - #8 are reported for openings and closings
- User Code #0 is reported for Quick Arming

The following options can be set for each RF keypad:

- **Select RF Keypad Number.** Select keypad number 1-4.
 - **Select RF Keypad # Used.** Enable or disable the keypad.
 - **Select RF Keypad # Equipment Code.** Select the sensor model for the keypad. See "Equipment Codes" on page 40.
 - **Select RF Keypad # Other Equipment Code.** If you selected (0000) Other, enter the special equipment code.
 - **Select RF Keypad # Serial #.** Enter the serial number from the keypad or "learn" by sending signal.
 - **Select RF Keypad # Equipment Age.** Select (0) New or (1) Existing.
 - **Select RF Keypad # Emergency Keys.** Select (1) Enabled or (0) Disabled.
- **Construct RF Keypad # Voice Descriptor.**

RF Keypad Programming Outline

Figure 55 Keypad Programming Outline

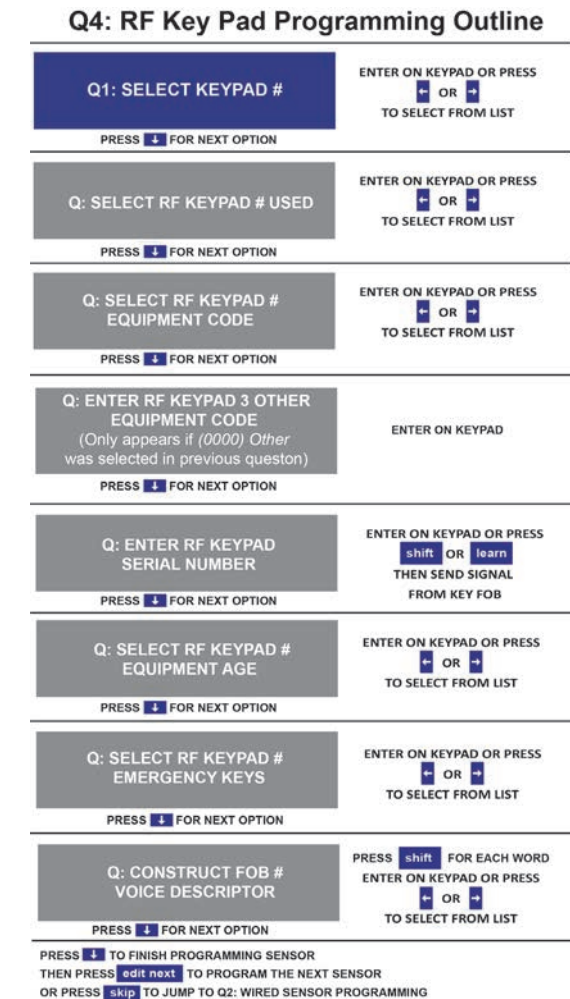

Scroll between options using the ← and → arrows. Move to the previous or next prompt by pressing the ↑ and ↓ arrows.

- 1 To program another sensor click **Next**.
- 2 To exit programming, click **Skip**, then **End**, and then **Exit**. Upon exit, the panel takes several seconds to restart.
- 3 Press **Skip** to jump to question Q4. See "RF Keypad Programming Questions" on page 52

Summary of RF Keypad Screen

After setting all the options for a sensor, the RF keypad summary screen is displayed. The screen can also be displayed for *programmed* RF keypads by pressing the **Sum** button.

- To return to programming, click the **Edit Current** or **Edit Next** buttons.
- Pressing **Skip** goes to question Q5 (Control Panel programming).
- To exit programming, click **Skip** then **End** and **Exit**. Upon exit, the Control Panel takes several seconds to restart.

RF Keypad Programming Questions

Q4: Select RF Keypad # (1 to 4)

Up to four (4) wireless keypads can be programmed for use with each Control Panel. The options for each sensor are programmed with sub-option questions:

- Begin by entering the RF Keypad number or select it using the ← or → arrows.
- Program the RF keypads by using the ↑ and ↓ arrows to select the sub-options.

To skip RF Keypad programming, press **Skip** to jump from question Q4 to question Q5 (Exit Delay programming).

Q: Select RF Keypad (#) Used (0 to 1)

DEFAULT: (0) Unused

Users can use RF keypads together with a Control Panel or not.

- The default setting (0) *Unused* sets all RF keypads as unused.
- To enable programming for this RF keypad, select (1) *Used*.

Q: Select RF Keypad (#) Equipment Code (0-9999)

DEFAULT: (0000) Other

The *RF keypad equipment code* defines the sensor's manufacturer and type.

- The default setting is (0000) *Other*.
- Select (0867) *2GIG Wireless Keypad*.
- Select (1059) *2GIG TS1 Wireless Touchscreen Keypad*.

NOTE: The 2GIG Wireless Touch Screen Keypad is not intended for *UL 985: Household Burglar-Alarm System Units* installations.

Q: Enter RF Keypad # Other Equipment Code (0-9999)

DEFAULT: 0

NOTE: This question is only displayed if (0000) *Other* is selected as the RF keypad's equipment code.

IMPORTANT: The equipment code is a four (4)-digit code that is assigned to the appropriate keypad model being used.

- Enter the equipment code number for the RF Keypad.

Q: Enter RF Keypad# Serial Number (7 Digits)

DEFAULT: 0000000

or

RF Keypad (#) Keypad ID (read-only)

Serial numbers for standard wireless keypads can be manually entered or learned from the keypad. For Wireless Touch Screen Keypads, serial numbers can **only** be learned from the keypad. Read-only with Keypad ID's refer to the installer being unable to manually input an id.

Standard Keypads:

- For manual entry, enter the Wireless Keypad that was logged for the keypad being programmed. Press the **Shift** button to access alpha characters.
- For automatic entry, press **Shift** and then **Learn**. This places the Control Panel into learning mode. When you trigger the keypad the sensor for the keypad being programmed, it sends its serial number to the Control Panel.

Wireless Touch Screen Keypads (only available in some regions):

- For Wireless Touch Screen Keypads press **Learn**. The Control Panel displays the "Pair with TS-1. Initiating learning process." Press the keypad's **Pair with Panel** button. When complete, the keypad and the Control Panel display "The learn operation succeeded" message.
- The Control Panel displays "RF Keypad (#1-4)" to identify the keypad.
- The keypad displays "Network ID: xxxx" which is its unique serial number.
- Press **OK** on both the Control Panel and the Wireless Touch Screen Keypad to continue.

NOTE: The Wireless Touch Screen Keypad will display "The security system is temporarily not operational" after learning the Keypad. This is normal, and will be displayed anytime the Control Panel is in system configuration (programming) mode.

Q: Select RF Keypad# Equipment Age (0 to 1)

DEFAULT: (0) New

The Control Panel can be used with new or existing RF keypads.

- If this RF Keypad is new for the installation, leave the default of (0) *New*.
- If this RF Keypad is already installed, select (1) *Existing*.

Q: Select RF Keypad# Emergency Keys (0 to 1)**DEFAULT: (1) Enabled****NOTE:** This step is not displayed for Wireless Touch Screen keypads.

Standard wireless keypads have 24-hour emergency buttons labeled Fire and Police.

- The default (1) enables this RF Keypad's emergency keys.
- To disable this RF Keypad's emergency keys, select disabled (0), the keys will not be able to trigger an alarm or report.

NOTE: The RF Keypad's POLICE button triggers a silent alarm if programming question *Q16: Police Emergency Key (0-2)* is set to (2) *Silent Panic*.**IMPORTANT:** To ensure that a signal is sent, instruct the end user to press and hold down the emergency key on the keypad until its indicator light illuminates.

Q: Construct RF Keypad# Voice Descriptor**DEFAULT: (#) Keypad**

The voice descriptor is the words the Control Panel will announce for this RF Keypad. Up to five words are allowed.

- 1 Press **Insert** to place a word from the vocabulary into the data entry field.
 - 2 Use the ← or → arrows to scroll through the words, or enter the word's 3-digit index number.
 - 3 Press **Insert** again for the next word. Up to five words are allowed.
 - 4 To remove a word, press **Delete**.
-

CONTROL PANEL PROGRAMMING

PROGRAMMING QUESTIONS

Q1: RF Sensor Programming

To learn about RF sensor programming, see "Wireless (RF) Sensor Programming" on page 41

Q2: Wired Sensor Programming

To learn about wired sensor programming, see "Wired Sensor Programming" on page 45

Q3: RF Key Fob Programming

To learn about RF key fob programming, see "Wireless (RF) Key Fob Programming" on page 48.

Q4: RF Keypad Programming

To learn about RF keypad programming, see "Wireless (RF) Keypad Programming" on page 51

Q5: Exit Delay, in Seconds (45-120)

DEFAULT: 60 seconds

The default minimum setting of 60 seconds is required for ANSI/SIA CP-01 compliance. The delay time can be increased without affecting compliance.

The exit delay timer can be set to a value between 45 to 120 seconds.

- The default setting 60 sets the exit delay to 60 seconds.
 - To change the exit delay timer, enter a value between 45-120 seconds.
-

Q6: Entry Delay 1, in Seconds (30-240)

DEFAULT: 30 seconds

The default minimum setting of 30 seconds is required for ANSI/SIA CP-01 compliance.

NOTE: For compliance with ANSI/SIA CP-01, the total number of minutes for the combination of Q6: Entry Delay 1 and Q35: Abort Window Dialer Delay cannot exceed one (1) minute.

The timer for Entry Delay 1 can be set to a value between 30 to 240 seconds.

- The default setting 30 sets the timer to 30 seconds.
 - To change the setting, enter a value between 30-240 seconds.
-

Q7: Entry Delay 2, in Seconds (30-240)

DEFAULT: 45 seconds

The default minimum setting of 45 seconds is required for ANSI/SIA CP-01 compliance.

NOTE: For compliance with ANSI/SIA CP-01, the total number of minutes for the combination of Q7: and Q35: Abort Window Dialer Delay cannot exceed one (1) minute.

The timer for Entry Delay 1 can be set to a value between 30-240 seconds:

- The default setting of 45 sets the timer to 45 seconds.
 - To change the timer setting, enter a value between 30-240 seconds.
-

Q8: Dialer (0-1)

DEFAULT: (0) Disabled

The dialer (digital communicator) can be enabled for a monitored system or disabled for a local alarm or when the GSM (Cellular) Radio Module is used exclusively for reporting.

- The default setting (0) Disabled turns the dialer OFF.
- To turn the dialer ON, select (1) Enabled.

IMPORTANT: If (0) Disabled is selected in Q8: Dialer, telephone line failure detection is also disabled regardless of the setting specified in Q63: Phone Fail Detect.

Q9: Dialing Prefix (0-4 Digits)

DEFAULT: No Default

Some telephone PBX systems require a dialing prefix to acquire a dial tone.

- If the telephone system that the Control Panel is connected to requires a dialing prefix, enter up to four (4) digits.
 - The **Shift** button accesses the pound and star symbols. The **P** button adds a three (3)-second pause to the dialing.
-

Q10: Call Waiting Disable Code (0-6 Digits)

DEFAULT: No default

For ANSI/SIA compliance, do not enter a disable code.

If the subscriber's telephone line has call waiting, incoming call tones on the line can interfere with reports to the Central Station. To prevent this, the system can be programmed to enter the code to deactivate call waiting before sending a report to the Central Station:

- If call waiting is active on the telephone line, enter the code to deactivate call waiting.
- The **Shift** button accesses the pound and star symbols. The **P** button adds a three (3)-second pause to the dialing.

NOTE: If the first attempt fails, this code will be ignored on the rest of the attempts.

Q11: CS #1 Phone Number (0-25 Digits)**DEFAULT: No Default**

Enter the telephone number for the Central Station #1. You can enter up to 25 digits.

- Enter the Central Station #1 telephone number.
- Access the pound and star symbols by pressing the **Shift** button. The **P** button adds a three (3)-second pause to the dialing.

NOTE: If a second Central Station telephone number is programmed with question *Q41: CS #2 Account Number*, the Control Panel alternates between the two Central Station telephone numbers. After two failed telephone dialing attempts, the Control Panel attempts to connect using the GSM (Cellular) Radio Module if it is installed. If the GSM (Cellular) Radio Module is not installed, the Control Panel will make eight (8) dialing attempts.

Q12: CS #1 Account Number (4 Digits)**DEFAULT: No Default**

Enter the account number for Central Station #1. This number is always four (4) digits and can include some alpha characters.

- Enter the four (4) digit for the Central Station #1 account number.
- The **Shift** button accesses B, C, D, E, and F characters.

Q13: 2-Way Voice (0-2)**DEFAULT: (1) Stay On Line**

The Control Panel supports two (2)-way voice communications between the subscriber and the Central Station operator over the telephone line or the GSM (Cellular) Radio Module (if installed) after an alarm has been reported.

- The (1) *Stay On Line* allows two (2)-way audio over the telephone line or cell radio.
- Selecting (2) *Stay On Line, Including Fire and CO Alarms* allows 2-way audio over the telephone line or cell radio during fire and CO alarms.
- To turn off the two (2)-way audio feature OFF, select (0) *Disabled*.

When the Control Panel connects with the operator, it will beep once per second (every 6 seconds with a cell radio connection). The beep alternates between two tones and indicates the Control Panel is waiting for a session command. If the operator fails to issue a command within one (1) minute (or three (3) minutes if using the cell radio connection), the call is terminated. Once the operator presses a command option, the beeps will stop and a five (5)-minute audio session will start (or three (3)-minute audio session if using the cell radio connection).

When two (2)-way voice communications have been established, the Central Station operator can use the following telephone keys to control the communications. Each time the operator uses a command key, the session is extended for five additional minutes (three minutes with a cell radio connection). During the last minute of communications, the system beeps two (2) times every 15 seconds to indicate that time is running out.

- Press **1** to enable Talk mode one (1)-way communication from the Central Station to the premises and allows the operator to talk.

- Press **2** to enable VOX mode two (2)-way communications from the Central Station to the premises.
- Press **3** to enable Listen mode one (1)-way communication from the premises to the Central Station.
- Press **7** to extend the session five (5) minutes without changing the mode of operation.
- Press **9** to end the audio session and terminate the call.

Q14: Silent Panic/Burglary Listen Only**DEFAULT: (1) Enabled**

The Control Panel supports audio listen-in of the subscriber premises from the Central Station over the telephone line after a silent panic (police emergency), silent burglary, or duress alarm has been reported.

- The default setting (1) *Enabled* allows the Central Station to use listen-in over audio after a silent panic, silent burglary, or duress alarm.
- This option is permanently set and cannot be disabled.

Q15: Dialing Type (0-1)**DEFAULT: (0) Touch Tone**

The digital communicator uses tones or pulses.

- The default setting (0) *Touch Tone* is for Dual-Tone Multi-Frequency (DTMF) dialing.
- For rotary dialing, select (1) *Pulse*.

Q16: Police Emergency Key (0-2)**DEFAULT: (1) Audible**

The Control Panel's panic emergency button action can be programmed. The panic emergency button is displayed by pressing the  button.

- The default (1) *Audible* allows the panic emergency button to sound an audible alarm.
- For silent activation, select (2) *Silent Panic*.
- To disable and not display the panic emergency button, select (0) *Disabled*.

NOTE: Setting this programming question for (2) *Silent Panic* makes the **Police** button on all RF keypads silent also.

Q17: Fire Emergency Key (0-1)**DEFAULT: (1) Audible**

The Control Panel's fire emergency button can be enabled or disabled. The fire emergency button is displayed by pressing the Control Panel's  button.

- The default setting (1) *Audible* allows the fire emergency button to sound an audible alarm.
- To disable and not display the fire emergency button, select (0) *Disabled*.

Q18: Emergency Key (0-1)

DEFAULT: (1) Audible

The Control Panel's emergency button can be enabled or disabled. The panel's emergency button is displayed by pressing the **Emergency**  button on the panel.

- The default setting (1) *Audible* sounds an audible alarm when the button is pressed.
- To disable this button, select (0) *Disabled*.

NOTE: If all three (3) Emergency buttons are disabled, the Control Panel displays a message when its **Emergency**  button is pressed.

Q19: Quick Arming (0-1)

DEFAULT: (1) Enabled

Quick arming allows the subscriber to arm the system without having to enter a user code. If Open/Close Reports are being sent, quick arming is reported as *User 0*.

- The default (1) *Enabled* allows quick arming.
- To turn off quick arming, select (0) *Disabled*.

Q20: Swinger Shutdown Count (1-6)

DEFAULT: (2) Two Trips

The minimum setting of (2) Two Trips is required for ANSI/SIA CP-01 compliance. This default setting can be increased to three or more trips without affecting ANSI/SIA CP-01 compliance.

An unwanted series of multiple faults (usually caused by a bad contact or sensor) is called a "swinger." Swinger shutdown sets the maximum number of alarms that any sensor or hardwire loop can trigger during a single arming period.

NOTE: CO and Smoke detector alarms are not limited by the swinger shutdown count. Other types of 24-hour zones are limited by the swinger shutdown count.

- The default setting (2) *Two-Trips* sets the swinger shutdown count at two (2) trips.
- To change this count, select (1-6).

Q21: Siren Supervision Time (0-3)

DEFAULT: (0) Disabled

The wiring connection to the external sounder can be supervised. If the wiring to the sounder is cut for 15, 30, or 45 seconds, a bell trouble report can be sent to the Central Station.

- The default setting (0) *Disabled* turns external sounder supervision OFF.
- To supervise the external sounder wiring, select:
 - (1) *15 Seconds*
 - (2) *30 Seconds*
 - (3) *45 Seconds*

Q22: CS Lack of Usage Notification Time (0-255)

DEFAULT: (7) Seven Days

If this system has not been armed for a specified number of days, inactivity reports can be sent to the Central Station.

- The default setting is (7) *Seven Days*.
- To change the duration, select a value between 1 to 255 days.
- To turn this feature OFF, select (0) *Disabled*.

Q23: Radio Modem Network Failure Time (0-255)

DEFAULT: 30 Minutes

NOTE: GSM (Cellular) Radio Module must be installed to use this function.

If the optional GSM (Cellular) Radio Module loses its cellular connection, specify the amount of down time that must pass before triggering a trouble condition.

- The default setting is 30 minutes.
- To specify a different amount of time, enter a value between one (1) to 255 minutes.

NOTE: After cellular service is restored for five (5) minutes, the trouble condition automatically clears.

Q24: Radio Modem Network Failure Causes Trouble (0-1)

DEFAULT: (1) Enabled

NOTE: GSM (Cellular) Radio Module must be installed to use this function.

Selects whether the Control Panel will sound and display trouble if the optional GSM (Cellular) Radio Module has lost its cellular connection. The trouble sounder can be silenced by the user at the Control Panel (cell radio trouble is logged regardless of this setting). When the cellular radio module connection is restored, the trouble indications automatically clear.

- The default (1) *Enabled* allows radio module failure trouble indications.
- To turn off radio module failure trouble indications, select (0) *Disabled*.

Q25: Radio Modem Network Failure Reports (0-1)

DEFAULT: (1) Enabled

NOTE: GSM (Cellular) Radio Module must be installed to use this function.

If the optional GSM (Cellular) Radio Module loses its cellular connection, the Control Panel can report the fault and restore via land-line if telephone reporting is enabled.

- The default (1) *Enabled* allows radio module failure/restore reporting.
- To turn off radio module failure/restore reporting, select (0) *Disabled*.

Q26: Auto Stay (0-1)**DEFAULT: (1) Enabled***This feature must be enabled for ANSI/SIA CP-01 compliance*

When auto stay is enabled and the system is armed in the **Away** mode, if an exit/ entry sensor is not violated during the Exit Delay, the system will arm in the **Stay** mode.

- The default setting is (1) *Enabled* which turns the auto-stay feature ON.
- To turn this feature off, select (0) *Disabled*.

NOTE: If the system is remotely armed in **Away** mode using a key fob, telephone, mobile app, or computer, the auto-stay feature will not switch the system to **Stay** mode.

Q27: Exit Delay Restart (0-1)**DEFAULT: (1) Enabled***This feature must be enabled for ANSI/SIA CP-01 compliance.*

When Exit Delay restart is enabled, re-entering the premises through an exit/ entry door during the Exit Delay will restart the Exit Delay. The restart of the Exit Delay will only occur one time; further violations of an exit/entry sensor will not extend the Exit Delay.

- The default setting (1) *Enabled* turns this feature ON.
- To turn this feature OFF, select (0) *Disabled*.

Q28: Quick Exit (0-1)**DEFAULT: (1) Enabled**

The quick exit feature allows the user to start the Exit Delay while the system is armed. When this feature is enabled, a **Quick Exit** button appears on the Security screen. Pressing **Quick Exit** while the system is armed allows the user to leave through an exit/entry door. After the Exit Delay expires, the system will return to being armed in the mode it was in before (either **Stay** or **Away** mode).

- The default setting (1) *Enabled* turns this feature ON.
- To turn this feature OFF, select (0) *Disabled*.

Q29: Periodic Test, in Days (0-255)**DEFAULT: 30 Days**

Recurring test reports can be automatically sent to the Central Station at a specified number of days.

- The default setting is **30**. This sends an automatic test report to the Central Station every 30 days.
- To change the number of days, enter a value between one (1) to 255 days.
- To disable this feature, select (0) *Disabled*.

Q31: Cancel Time, in Minutes (5-255)**DEFAULT: 5 minutes***The minimum setting for ANSI/SIA CP-01 compliance is 5 minutes. The number of minutes can be increased without affecting ANSI/SIA CP-01 compliance.*

A cancel report will be sent to the Central Station after an alarm, if the system is disarmed within the programmed time.

- The default setting for the cancellation time is five (5) minutes.
- To extend this time interval, enter a value between six (6) to 254 minutes.
- To always send a cancel report when the system is disarmed after an alarm, enter 255.

NOTE: See Q32: *Cancel Display* for information on displaying when a cancel report is sent.

Q32: Cancel Display (0-1)**DEFAULT: (1) Enabled***This feature must be enabled for ANSI/SIA CP-01 compliance.*

A cancel report will be sent to the Central Station after an alarm, if the system is disarmed within the programmed time. The Control Panel can also display that a cancel report was sent.

- The default setting (1) *Enabled* enables the cancel display feature.
- To turn off the cancel display feature, select (0) *Disabled*.

NOTE: See Q31: *Cancel Time, in Minutes* for information on setting the cancel report trigger time.

Q33: Cross Sensor 47-48 (0-1)**DEFAULT: (0) Disabled**

The Control Panel can be programmed so sensors 47 and 48 must both be violated during a set time to trigger an alarm. This is called "cross sensor" verification. When enabled, if only one sensor (47 or 48) is violated, the alarm will not trigger, but a trouble report will be sent for the sensor that triggered.

NOTE: CO and Fire zone cannot be used for cross sensors.

- The default setting (0) *Disabled* turns the cross sensor feature OFF.
- To turn the cross sensor feature ON, select (1) *Enabled*.

NOTE: See Q34: *Cross Sensor Timeout, in Seconds* for information on setting the cross sensor timeout.

Q34: Cross Sensor Timeout, in Seconds (10-120)

DEFAULT: 10 Seconds

The cross sensor timeout is the maximum period of time allowed between violation of sensors 47 and 48 that will trigger an alarm. If both sensors are violated within this time period, an alarm will be triggered. If both sensors are not violated within this time period, an alarm will not be triggered.

NOTE: Cross sensor verification must be enabled with Q33: *Cross Sensor 47-48* for this feature to function.

- The default setting for the cross sensor timeout is 10 seconds.
- To change the timeout duration, enter a valued between 11 to 120 seconds.

Q35: Abort Window Dialer Delay (0-2)

DEFAULT: (1) 30 Seconds

The default minimum setting for ANSI/SIA CP-01 compliance is 30 seconds.

The delay time can be increased to 45 seconds without affecting ANSI/SIA CP-01 compliance only if the combination of Q35 and Q6 or Q7 does not exceed one (1) minute.

NOTE: The dialer delay can be disabled for each sensor without affecting ANSI/SIA CP-01 compliance. See "RF Sensor Programming Questions" on page 42.

The dialer (digital communicator) delays calling the Central Station to allow the user enough time to cancel a false alarm before it is reported.

- The default setting is (1) 30 Seconds.
- To change the setting, select (0) 15 Seconds or (2) 45 Seconds.

Q36: Burglary Bell Cutoff (0 to 4)

DEFAULT: (0) 4 Minutes

When a burglary alarm is triggered, the bell will sound until the burglary bell cutoff time expires.

- The default setting for the burglary bell cutoff is (0) 4 Minutes.
- To change the cutoff time, select an option below.

Burglary Bell Cutoff Time

- (0) 4 Minutes
- (1) 8 Minutes
- (2) 12 Minutes
- (3) 16 Minutes
- (4) Unlimited

NOTE: The 24-hour Auxiliary Alarm Zone (08) does not follow the burglary bell cutoff time and will sound the Control Panel's local alarm until a User Code is entered. The Auxiliary Alarm Zone does not trigger the external siren (if used).

Q37: Fire Bell Cutoff (0-4)

DEFAULT: (0) 4 Minutes

When a fire alarm is triggered, the bell sounds until the fire bell cutoff time expires.

- The default setting (0) 4 Minutes sets the burglary bell cutoff to four (4) minutes.
- To change the fire bell cutoff time, select an option below

Fire Bell Cutoff Time

- (0) 4 minutes
- (1) 8 minutes
- (2) 12 minutes
- (3) 16 minutes
- (4) Unlimited

Q38: Time to Detect AC Loss, in Minutes (0-30)

DEFAULT: (10) 10 Minutes

When AC power is lost, the system displays a power loss alert  after the specified time length. When power is restored, the alert is automatically cleared after one (1) minute.

- The default detection timer for displaying the alert message is (10) 10 Minutes.
- To change the detection timer, enter a value between 0 to 30 minutes.

NOTE: After the AC power alert  is displayed or clears, the AC power loss report or AC power restore report can be sent to the Central Station immediately, or at a random time, see Q39: *Random AC Loss Report Time*.

NOTE: The Control Panel's AC Power Icon immediately displays the power status. See "AC Power On/OFF" on page 29.

Q39: Random AC Loss Report Time (0-1)**DEFAULT: (1) Enabled**

This feature allows the system to report AC power loss and AC power restore at a random time of up to 45 minutes after the event occurs. This helps to reduce Central Station congestion due to a wide-spread power outage affecting many Control Panels at once. The random AC power status report timer is triggered based on the time set by Q38: *Random AC Loss Report Time*.

- The default setting (1) *Enabled* turns this feature ON.
- To turn this feature OFF, select (0) *Disabled*.

Q40: CS #2 Phone Number (0-25 digits)**DEFAULT: No Default**

The telephone number for Central Station #2 can be up to 25 digits. Central Station telephone #2 is dialed as backup in case telephone #1 does not connect.

- Enter the Central Station #2 telephone number.
- The **Shift** button accesses the pound and star symbols. The **P** button adds a 3-second pause to the dialing.

Q41: CS #2 Account Number (4 Digits)**DEFAULT: No Default**

The account number for Central Station #2 is always four digits and can include some alpha characters.

- Enter four (4) digits for the Central Station #2 account number.
- The **Shift** button accesses B, C, D, E, and F characters.

Q42: Remote Control Phone (0-3)**DEFAULT: (3) Data and Voice**

This setting controls remote telephone access to the system.

- **The data option is for the installer.** It allows access for programming and operating the system with custom PC downloader software.
- **The voice option is for the subscriber.** It allows the subscriber to call the system from an off-site phone, to get the status of the system, and to perform remote commands. These commands are executed by entering touch tones. The status is reported back via voice prompts. A valid User Code is required for remote telephone access. The user can perform the following functions: arm in any mode, disarm, bypass, get system status, and turn on or turn off the open collector output.

If voice access is enabled, to connect to the panel, the subscriber will need to call the telephone number that the Control Panel is connected to, wait for one or two rings, then hang up. The subscriber needs to call again, within 10-45 seconds. The Control Panel answers the call.

When the panel answers the phone, the user will be prompted to enter their code. If a valid code is entered, the system will announce the current system status. If an invalid code is entered, the panel will ask for the code again. After two invalid attempts, the panel will disconnect. After two calls, with two invalid attempts each, the panel will lock out. The lock out will last for 30 minutes.

- The default setting is (3) *Data and Voice*.
- To use data access only, select (1) *Data Only*.
- To use voice access only, select (2) *Voice Only*.
- To turn the remote access feature OFF, select (0) *Disabled*.

Telephone Key	Remote Control Phone Mode
1	System status report
2	Arm the system in Away mode
3	Arm the system in Stay mode
4	Disarm the system
5	Turn on the auxiliary output
6	Turn off the auxiliary output
7	Stop the system status report
8	Disconnect (hang up)
9	Repeat command menu
#	Bypass all open sensors and arm system

NOTE: Remotely arming the system to **Away** mode will not start an **Exit Delay** or activate **Auto Stay** mode (if enabled).

Q43: Installer Code (4 Digits)

DEFAULT: 1561

The *installer code* is a unique code that installation technicians use to access the Installer Toolbox on the Control Panel.

- The default installer code is **1561**.
- To change the installer code, enter a new four (4)-digit code.

IMPORTANT: If you change the installer code, always write it down so you can access the system later.

NOTE: The *installer code* must be unique from the *master user code* and all other user codes.

Q44: Lock Installer Programming (0-2)

DEFAULT: (0) Disabled

The installer programming lockout feature is provided to prevent takeovers. The Control Panel can be set to limit an installer's access to programming questions after a period of 48 hours. The 48-Hour Lockout timer starts when the installer exits System Configuration mode.

Three (3) options are available:

- Unlimited full access to programming (no lockout)
- Limited access to programming after 48 hours
- No access to programming after 48 hours

The default setting *(0) Disabled* selects unlimited full access to programming (no lockout).

To deny access to programming after 48 hours, select *(1) No Access to Programming*.



If you select *(2) Limited Access to Programming* the installer will be able to view, but not change the following attributes after the system has run for 48 hours, the Central Station phone number, Central Station account number, lock installer programming, download ID, and default lockout fields.

After the 48 hour lockout timer has locked out the system, the timer can be reset through the cell radio or PC download by remotely setting this question to (0) or (2). Setting the option to (0) or (2) will restart the 48 hour lockout timer.

Q45: Lock Default Programming (0-2)

DEFAULT: (0) Default All

The Control Panel may be able to be hard reset (or soft reset from the Installer Toolbox) to its factory default values depending on the value entered for this programming question.

The Control Panel is hard reset by pressing and holding the  and  buttons while applying power to the Control Panel.

The default lockout feature is provided to prevent takeovers. Three options are available: allow default of all options, allow default of some but not all options, not allow default of any options.

- The default setting of *(0) Default All* allows resetting the Control Panel to all its factory defaults.
- To allow resetting the Control Panel to all its factory defaults except the Central Station phone number, Central Station account number, lock installer programming, download ID, and default lockout

fields, select *(1) Default All Except CSID, Account/Phone, Lockouts*.

- To deny hard and soft resetting of the Control Panel, select *(2) Default None*.

If option 1 or 2 is selected, the option takes effect after the system runs for 48 hours. This allows the installer to go back and make changes if required.

Q46: Trouble Doesn't Sound at Night (0-1)

DEFAULT: (1) Enabled

NOTE: For *UL 985: Household Fire Warning System Units* installations, this setting must be set to *(0) Disabled*

The Control Panel will sound trouble beeps caused by AC loss, system low battery, sensor low battery or RF supervision, failure to communicate, Control Panel tamper while disarmed, and cell radio faults.

To prevent annoying the subscriber, the system can be set to suppress trouble beeps from sounding from 10 PM to 9 AM. The trouble alerts are still displayed and immediately reported to the Central Station, and can be acknowledged, but they won't sound beeps until after 9 AM.

If the trouble condition(s) self-clear or are acknowledged before 9 AM, no trouble beeps sound after 9 AM (the conditions are still recorded in the event log).

- The default setting *(1) Enabled* suppresses trouble beeps from 10 PM to 9 AM
- To allow trouble beeps at any time, select *(0) Disabled..*

Q47: Trouble Resound After Hold Off (0-7)

DEFAULT: (0) Disabled

Fire and CO sensors are required to re-sound trouble beeps every four hours until the trouble is resolved, even if the trouble is acknowledged at the Control Panel. The Control Panel can be set to delay re-sounding these types of trouble beeps for 1-7 days.

NOTE: This feature is not allowed in UL 985 installations. The setting must be *(0) Disabled* in this grade of installation.

- The default setting *(0) Disabled* allows trouble beeps for CO and fire sensors to re-sound every four (4) hours after being acknowledged
- To delay re-sounding trouble beeps for CO and Fire sensors, select (1-7) days

Q48: Download CSID (6 Digits)

DEFAULT: 000000

The system supports a six (6)-digit CSID code that is used for remote telephone programming of the Control Panel. This code is verified when the Control Panel connects with the downloading software. If the CSID code doesn't match the downloading software, the Control Panel will deny the connection.

- The CSID code can be entered manually with this programming question.
 - If this field is left with the default (000000), the first time the downloading software connects with the Control Panel, the field will be filled with the software's CSID.
-

Q49: Programming Mode Entry Reports to CS (0-1)

DEFAULT: (0) Disabled

A report can be sent to the Central Station any time installer programming mode is entered and exited.

- The default setting (0) *Disabled* prevents reporting programming mode entry and exit.
- To report programming mode entry and exit, select (1) *Enabled*.

NOTE: This report can only be sent through the telephone dialer. It is not supported through the GSM (Cellular) Radio Module.

Q50: Trouble Reports to CS (0-1)

DEFAULT: (1) Enabled

Trouble reports can be sent to the Central Station when any sensor trouble condition occurs.

- The default setting (1) *Enabled* allows reporting sensor trouble conditions.
- To not report sensor trouble conditions, select (0) *Disabled*.

NOTE: This setting does not affect trouble reports caused by Control Panel conditions, only trouble reports caused by sensors.

Q51: Manual Bypass Reports to CS (0-1)

DEFAULT: (0) Disabled

Manual bypass reports can be sent to the Central Station when any sensor has been manually bypassed by the user.



- The default setting (0) *Disabled* prevents sending manual bypass reports.
 - To allow sending manual bypass reports, select (1) *Enabled*.
-

Q52: AC Loss Reports to CS (0-1)

DEFAULT: (1) Enabled

AC power loss reports can be sent to the Central Station if the Control Panel loses AC power.

- The default setting (1) *Enabled* allows AC power loss reports.
- To turn off AC power loss reports, select (0) *Disabled*.

NOTE: The AC power will have to be absent from the Control Panel for the time set by programming question Q38 before the AC power loss trouble alert  is displayed (the default is 10 minutes). If programming question Q39 is enabled, the actual AC power loss report will occur at a random time of up to four hours after the AC power loss trouble alert  is displayed.

NOTE: The Control Panel's AC power icon displays the power status immediately. A red "X" over the icon indicates no AC power.

Q53: System Low Battery Reports to CS (0-1)

DEFAULT: (1) Enabled

Low battery reports can be sent to the Central Station if the Control Panel's battery tests low.

- The default (1) *Enabled* allows Control Panel low battery reports.
 - To turn off Control Panel low battery reports, select (0) *Disabled*.
-

Q54: RF Low Battery Reports to CS (0-1)

DEFAULT: (1) Enabled

Sensor low battery reports can be sent to the Central Station if a sensor battery tests low and sends a low battery transmission to the Control Panel.

- The default setting is (1) *Enabled* and allows the system to send low battery reports for sensors.
 - To turn this feature OFF, select (0) *Disabled*.
-

Q55: Opening Reports to CS (0-1)

DEFAULT: (0) Disabled

Opening reports can be sent to the Central Station each time the system is disarmed. The user or key fob number is indicated in the opening report.

- The default setting (0) *Disabled* prevents opening reports.
 - To allow opening reports, select (1) *Enabled*.
-

Q56: Closing Reports to CS (0-1)

DEFAULT: (0) Disabled

Closing reports can be sent to the Central Station each time the system is armed. The user or key fob number is indicated in the closing report. If Quick Arming is enabled, User #0 is indicated for the closing report.

- The default setting (0) *Disabled* prevents closing reports.
 - To allow closing reports, select (1) *Enabled*.
-

Q57: Alarm Restore Reports to CS (0-1)**DEFAULT: (0) Disabled**

Alarm restore reports can be sent to the Central Station after an alarm when either the bell timeout has been reached or the system is disarmed. If alarm restores are enabled and swinger shutdown is set to two, a restore will be reported if the sensor is closed (normal state) at bell cutoff or becomes closed after bell cutoff. If swinger shutdown is set to one, a restore will only be sent if the sensor is closed at the time of disarm. Restores are not sent if a sensor is in swinger shutdown until the time of disarm and the sensor is closed.

- The default setting (0) *Disabled* prevents alarm restore reports.
- To allow alarm restore reports, select (1) *Enabled*.

Q58: Trouble Restore Reports to CS (0-1)**DEFAULT: (1) Enabled**

Trouble restore reports can be sent to the Central Station when any sensor trouble condition clears.

- The default setting (1) *Enabled* allows the system to send reports when trouble conditions are restored.
- To turn this feature OFF, select (0) *Disabled*.

Q59: Bypass Restore Reports to CS (0-1)**DEFAULT: (0) Disabled**



Bypass restore reports can be sent to the Central Station when any sensor that was force bypassed or manually bypassed gets restored.

- The default setting (0) *Disabled* prevents bypass restore reports.
- To allow bypass restore reports, select enabled (1) *Enabled*.

Q60: AC Restore Reports to CS (0-1)**DEFAULT: (1) Enabled**

AC power restore reports can be sent to the Central Station when the Control Panel regains AC power after an AC power loss.

- The default setting (1) *Enabled* allows AC power restore reports.
- To turn off AC power restore reports, select (0) *Disabled*.

NOTE: The AC power will have to be restored to the Control Panel for one minute before the AC power loss trouble alert  automatically clears. If programming question Q39 is enabled, the actual AC power restore report will occur at a random time of up to four hours after the AC power loss trouble alert  has cleared.

NOTE: The Control Panel's AC power icon displays the power status. A red "X" over the icon indicates no AC power.

Q61: System Low Battery Restore Reports to CS (0-1)**DEFAULT: (1) Enabled**

When a low battery condition is restored on the Control Panel, the system can send a restore report to the Central Station.

- The default setting (1) *Enabled* allows the system to send reports when low battery conditions are restored.
- To turn this feature OFF, select (0) *Disabled*.

Q62: RF Low Battery Restore Reports to CS (0-1)**DEFAULT: (1) Enabled**

Sensor low battery restore reports can be sent to the Central Station if a sensor battery had tested low and is now OK.

- The default setting (1) *Enabled* allows sensor low battery restore reports.
- To turn off sensor low battery restore reports, select (0) *Disabled*.

Q63: Phone Fail Detect (0-1)**DEFAULT: (0) Disabled**

The system can monitor the telephone line connected to the Control Panel. If the telephone line is shorted or cut, the Control Panel will indicate telephone line trouble by sounding trouble beeps and displaying the no-phone icon.

If the optional GSM (Cellular) Radio Module is installed, the telephone line failure will still be reported if this question is enabled.

- The default setting (0) *Disabled* turns this feature OFF.
- To turn on this feature, select (1) *Enabled*.

NOTE: If (0) *Disabled* is selected in Q8: *Dialer*, telephone line failure detection is also disabled regardless of the setting specified here in Q63: *Phone Fail Detect*.

Q64: Smart Test Reports**DEFAULT: (0) Disabled**

Smart test reports are a way to reduce Central Station traffic. If smart test reports are enabled and regular periodic test reports are enabled, any non-test report to the Central Station (alarm, restore, trouble, etc.) during the normal operation of the system will reset the periodic test report timer. Periodic test reports would only be sent if the Control Panel has not reported in any way to the Central Station.

- The default setting (0) *Disabled* prevents smart test reports.
- To allow smart test reports, select (1) *Enabled*.

Q65: RF Jam Causes Trouble (0-1)**DEFAULT: (0) Disabled**

The system can monitor the Control Panel's sensor receiver and detect whether a transmitter is stuck on the air causing jamming. When jam detect is enabled, the Control Panel will indicate a trouble condition if RF jamming is detected.

NOTE: This programming question only functions if trouble reports are enabled with programming question Q50.

- The default setting (0) *Disabled* turns RF jam detection OFF.
- To turn on RF jam detection, select (1) *Enabled*.

Q66: Daylight Saving (0-1)**DEFAULT: (1) Enabled**

The Control Panel can adjust its displayed clock and internal clock for Daylight Saving Time (DST). If the cell radio is used, the time will be automatically adjusted regardless of this setting. The system default is set to use the current start (March) and end (November) dates for the United States. The DST start and end dates can be adjusted as follows:

- The default setting (1) *Enabled* turns ON the DST clock for the system.
- To turn off the DST clock, select (0) *Disabled*.

NOTE: If enabled, respond to programming questions Q67, Q68, Q69, and Q70 to modify the start and stop values for DST.

Q67: Daylight Saving Start Month (01-12)**DEFAULT: (03) March**

- The default DST start month is set to (03) *March*.
- To change the start month for your country, region, or state, enter the desired month, (01-12) *January - December*:

Q68: Daylight Saving Start Monday (1-7)**DEFAULT: (2) 2nd Sunday**

- The default (2) sets the second Sunday as the daylight saving start week.
- To change the start week, enter the 1st, 2nd, 3rd, 4th, last, second from last, third from last (1-7) as the daylight saving start week.

Q69: Daylight Saving End Month (01-12)**DEFAULT: (11) November**

- The default (11) *November* defines the daylight saving end month.
- To change the end month for your country, region, or state, enter the desired month, (01-12) *January - December*.

Q70: Daylight Saving End Sunday (1-7)**DEFAULT: (1) 1st Sunday**

- The default setting (1) *1st Sunday* defines the daylight saving end week.
- To change the end week, enter the 1st, 2nd, 3rd, 4th, last, second from last, third from last (1-7) as the daylight saving end week.

Q71: System Tamper Causes Trouble (0-1)**DEFAULT: (1) Enabled**

A tamper switch on the Control Panel detects if the case has been opened. The system can be programmed so that a tamper switch activation will cause a trouble indication if the system is disarmed, and an alarm if the system is armed.

- The default (1) allows the Control Panel tamper switch to trigger trouble when the system is disarmed, and alarm when the system is armed.
- To have the system ignore the Control Panel tamper switch, select (0) *Disabled*.

Q72: Quick Bypass (0-1)**DEFAULT: (0) Disabled**

Normally, sensors that are violated (open) at the time the system is armed will require the user to enter their code to force bypass them. The Control Panel can be programmed so that when the system is armed with open sensors, a code is not required to bypass the open sensor(s) and complete the arming.

- The default setting (0) *Disabled* requires entering a code to bypass sensors.
- To allow bypassing sensors without a code, select (1) *Enabled*.

Q73: Disarming Keyfob After Alarm (Alert) (0-1)**DEFAULT: (0) Disabled**

The system can produce a unique sound when it's disarmed with a key fob after an alarm has occurred. Four beeps will sound from the Control Panel's speaker, four chirps will sound from the external sounder (if installed). This feature serves as a safety alert to the user so they can enter the protected premises with caution.

- The default setting (0) *Disabled* will not cause a unique sound when disarming after an alarm.
- To cause unique sound when disarming after an alarm, select (1) *Enabled*.

Q74: Keyfob Arm/Disarm Confirmation (0-1)**DEFAULT: (0) Disabled**

The system can produce a unique sound when it's armed or disarmed with a key fob. The Control Panel's speaker will sound one beep when arming and two beeps when disarming. The external sounder (if installed) will sound one chirp when arming and two chirps when disarming (four beeps after an alarm if Q73 is enabled). This feature indicates to the user that their key fob signal was received by the Control Panel in case other arm/disarm indications (armed LED, etc.) are not available or visible to the user.

- The default setting (0) *Disabled* will not cause a unique sound when controlled by a key fob.
- To cause a unique sound when controlled by a key fob, select (1) *Enabled*.

Q75: Auto Un Bypass for Manual Bypass (0-1)

DEFAULT: (1) Enabled

Violated (open) sensors can be manually bypassed by the user through the User Toolbox or force bypassed at the time of arming.

Force bypassed sensors automatically have their bypasses removed when the system is disarmed.

Manually bypassed sensors can have their bypass automatically removed at disarming or have their bypasses remain in place.

- The default setting (1) *Enabled* automatically removes bypasses from manually bypassed sensors when the system is disarmed.
- To have manually bypassed sensors remain bypassed when the system is disarmed, select (0) *Disabled*.

Q76: Force Bypass Reports (0-1)

DEFAULT: (0) Disabled

The system can report which sensors have been force bypassed by the user when the system is armed. Forced bypassed sensors are always recorded in the event log, regardless of the setting of this programming question.

- The default setting (0) *Disabled* prevents reporting forced bypassed sensors.
- To report forced bypassed sensors, select (1) *Enabled*.

Q77: Event Log (0-3)

DEFAULT: (3) All Events

To control the amount of event log entries, the events that get recorded into the system's event log can be selected by type. This setting filters the events that populate the event log.

- The default setting (3) *All Events* records all events in the event log.
- To choose different options, select one of these filters:

Event Log Filters

- (0) Disabled (no events logged)
- (1) All Events Except Open, Closing, and Bypass
- (2) All Events Except Open and Closing
- (3) All Events

Q78: Output

DEFAULT: (11) Follows Internal Sounder Alarm

The default setting for ANSI/SIA CP-01 is (11) *Follows Internal Sounder Alarm*.

The system's open collector output is available on the Control Panel's terminal block to connect to an external device. The conditions that will cause the open collector output to activate are programmable.

Select one of the settings below:

Open Collector Output Mode

- (00) Disabled
- (01) Activated When Armed
- (02) Activated When Disarmed

Open Collector Output Mode

- (03) Activated on FTC (Failure to Communicate)
- (04) Activated on Siren Supervision
- (05) Activated on Radio Fault
- (06) Activated on Burglary Alarm
- (07) Activated on Fire Alarm
- (08) Activated on Any Alarm
- (09) Activated on Any System Trouble
- (10) Z-Wave activation (Option #10 not currently active)
- (11) Follows Internal Sounder Alarm
- (12) Follows Exit/Entry Beeps

Q79: Z-Wave Feature (0-3)

DEFAULT: (1) Disabled but Visible

The Z-Wave home services feature can be enabled or disabled with various remote control access options.

- The default setting (1) *Disabled but Visible* displays the **Services** button, but will show a message that the feature is currently disabled and the user should call the installer.
- To hide the **Services** button, select (0) *Disabled and Hidden*.
- To show the **Services** button and disable off-site remote control, select (2) *Enabled on Panel, Remote Access Disabled*.
- To show the **Services** button, with Z-Wave rules disabled and off-site remote control enabled, select (3) *Enabled on Panel, Rules Disabled, Remote Access Enabled*.

Q80: Z-Wave Switches Feature (0 to 1)

DEFAULT: (0) Disabled

Display of the Home Service's **Switches** button can be enabled or disabled.

NOTE: This programming question only functions if Q79: *Z-Wave Feature* is set to (2) or (3).

- The default setting (0) *Disabled* hides the **Switches** button.
- To show the **Switches** button, select (1) *Enabled*.

Q81: Z-Wave Thermostats Feature (0 to 1)

DEFAULT: (0) Disabled

Show or hide the Home Service's Thermostats button on the Control Panel.

NOTE: This programming question only functions if Q79: *Z-Wave Feature* is set to (2) or (3).

- The default setting (0) *Disabled* hides the **Thermostats** button.
- To display the **Thermostats** button, select (1) *Enabled*.

Q82: Z-Wave Door Locks Feature (0-1)**DEFAULT: (0) Disabled**

Display of the Home Service's **Door Locks** button can be enabled or disabled. This programming question only functions if the Z-Wave feature enable question Q79: *Z-Wave Feature* is set to (2) or (3).

- The default setting (0) *Disabled* hides the **Door Locks** button.
- To display the **Door Locks** button, select (1) *Enabled*.

Q83: Select Temperature Display Units (0-1)**DEFAULT: (0) Degrees Fahrenheit**

The Home Service's Z-Wave thermostat display screens can show the temperature in degrees Fahrenheit or degrees Celsius.

NOTE: This programming question only functions if Q79: *Z-Wave Feature* is set to (2) or (3) and Q81: *Z-Wave Thermostats Feature* is set to (1) *Enabled*.

- The default setting is (0) *Degrees Fahrenheit*.
- To change the setting, select (1) *Celsius*.

NOTE: The setting you select here also changes the display units shown on the weather forecast on the Control Panel's Home screen.

Q84: Services Require Master Code (0 to 1)**DEFAULT: (0) Disabled**

The **Services** button can be configured to require the use of the master user code to access Services.

- The default setting (0) *Disabled* overrides the requirement to enter a master user code to access the **Services** menu.
- To require the use of the master user code to access the **Services** menu, select (1) *Enabled*.

When enabled then the master user code is required to access the Services and the Z-Wave device configurations. This keeps unauthorized users from being able to change Z-Wave settings, such as temperature, lights and locks.

Q85: Master User Access to Z-Wave Toolbox (0-1)**DEFAULT: (0) Disabled**

The Z-Wave Toolbox menu can be set to require the use of the master user code or the installer code. By default, the installer code is required for users to access the Z-Wave Toolbox.

- The default setting (0) *Disabled* requires users to enter the installer code to access the Z-Wave Toolbox menu and all of its features, including the Advanced Toolbox.
- To require the use of the master user code or the installer code to access the **Z-Wave Toolbox** menu, select (1) *Enabled*.

NOTE: When (1) *Enabled*, the Installer code will still be required to access the Advanced Toolbox menu. This prevents end users from adding or removing Z-Wave devices.

Q86: Disable Siren After Two-Way Audio (0-1)**DEFAULT: (0) Disabled**

This setting enhances system operation in personal emergency applications and also provides the dealer with the option of the siren sounding until the bell cut off or to the end of a two-way-voice session.

- The default setting (0) *Disabled* will cause the siren to resume after two-way audio (if the bell cut off timer has not expired).
- (1) *Enabled* will cause the siren to shut off after a two-way audio session.

Q87: Keyfob/Remote Arming Mode on System Not Ready (0-2)**DEFAULT: (0) Auto Bypass with Zone Participation on Restore**

This setting controls how the system will react when there are open sensors and the system is armed remotely.

- The default setting (0) *Disabled* will automatically bypass all sensors that are open when the system is armed remotely. If a sensor restores while the system is armed, the sensor's bypass will be removed, and the sensor will be ready to trigger an alarm.
- To automatically bypass all sensors that are open when the system is armed remotely, and keep all bypasses in place during the arming cycle, even if a sensor restores, select (1) *Auto-Bypass*.
- To prevent arming remotely when any sensor is open, select (2) *Arm Only When Ready*.

Q88: Siren Mode (0-1)**DEFAULT: (0) Sound for Burglary and Fire/CO**

This setting selects which alarm types will activate a Z-Wave siren linked to the system.

The default setting (0) *Sound for Burglary and Fire/CO* causes a Z-Wave siren to sound during burglary and Fire/CO alarms.

- To have a Z-Wave siren sound only during burglary alarms, select (1) *Sound for Burglary Only*.

Q89: Allow Backlight Always On (Demo Mode) (0-1)

NOTE: May cause ghost/image retention.

DEFAULT: (0) Disabled

When set to (1) *Enabled* the customer can program the "always on" option for backlight programming. Due to a small percentage of image "ghosting" on the panel (because the backlight never goes off), this question was created but has been defaulted to (0) *Disabled*.

Q90: Energy Feature (0 to 1)**DEFAULT: (0) Disabled and Hidden**

Select (1) *Disabled but Visible* to show but not activate the energy features. You can also select (2) *Enabled* to turn the energy feature ON.

Q91: Radio Modem Supplier**DEFAULT: (0) None**

NOTE: If you enable Q44: *Select Lock Installer Programming*, you will not be able to change this setting.

Select the option that corresponds to the appropriate supplier. Options include:

- (1) *Radio Modem Supplier 1*. Select this option if the radio modem is supplied by Alarm.com.
- (2) *Radio Modem Supplier 2*. Select this option if the radio modem is supplied by the Telular Corporation.

Q92: Network Device (0 to 1)**DEFAULT: (0) None**

When enabled, the (1) *Go!Bridge* option provides the installer to program the Go!Bridge IP Communicator settings into the Control Panel.

Q: Port # (1 to 8)**DEFAULT: (1) Port 1**

NOTE: Typically, you will skip this question unless additional programming is required.

Enter the port number for the backend server.

Q: Used (0 to 1)**DEFAULT: (0) Disabled**

NOTE: Typically, you will skip this question unless additional programming is required.

It is recommended that you always select the default setting (0) *Disabled*. If you choose (1) *Enabled*, you will be prompted to enter the port value as shown in the next question.

Q: Port Value (0 to 65535)**DEFAULT: (0) Disabled**

NOTE: Typically, you will skip this question unless additional programming is required.

It is recommended that you always select the default setting (0) *Disabled*.

However, if you select (1) *Enabled* in **Q: Select Used (0 to 1)**, enter the port value. The port value is the port number that must be specified to communicate over the Transmission Control Protocol (TCP). Port numbers can range from 0 to 65535.

Q: Port Forward IP Address**DEFAULT: 000.000.000.000**

Typically, you will simply accept the default IP Address value that appears.

Q93: Enter Broadband Network Failure Time (1-255)**DEFAULT: 30 Minutes**

NOTE: The Go!Bridge IP Communicator must be installed to use this function.

Sets the amount of time required for triggering a trouble condition if the system detects that the broadband network has lost its connection. After the connection has been restored, the trouble condition clears.

- The default failure detection setting is 30 minutes.
- To choose a different failure detection time, enter the number of minutes between 1-255.

Q94: Select Broadband Network Failure Causes Trouble (0 to 1)**DEFAULT: (1) Enabled**

NOTE: The Go!Bridge IP Communicator must be installed to use this function.

Selects whether the Control Panel will sound and display a trouble alert if the Go!Bridge IP Communicator loses its broadband connection. The trouble alert can be silenced by the user at the Control Panel (broadband trouble is logged regardless of this setting). When the broadband connection is restored, the trouble indications automatically clear.

- The default setting (1) *Enabled* allows Go!Bridge network failure trouble indications.
- To turn off Go!Bridge trouble indications, select (0) *Disabled*.

Q95: Select Broadband Network Failure Reports (0 to 1)**DEFAULT: (1) Enabled**

NOTE: The Go!Bridge IP Communicator must be installed to use this function.

If the Go!Bridge IP Communicator loses its broadband connection, the Control Panel can report the fault.

- The default setting is (1) *Enabled* which turns broadband network failure reporting ON.
- To turn broadband network failure reporting OFF, select (0) *Disabled*.

FINAL INSTALLATION SETUP

Exiting Programming (System Configuration)

After programming the Control Panel, all the changes need to be saved in memory. After saving, the programmed settings will remain in memory, even after a total power loss.

- 1 After setting all the required programming values for the sensors and the Control Panel, press **End**.
- 2 Review the **Summary of System Configuration** screen. Use the ↓ and ↑ arrows to scroll through the listing. Verify that each option is set correctly.

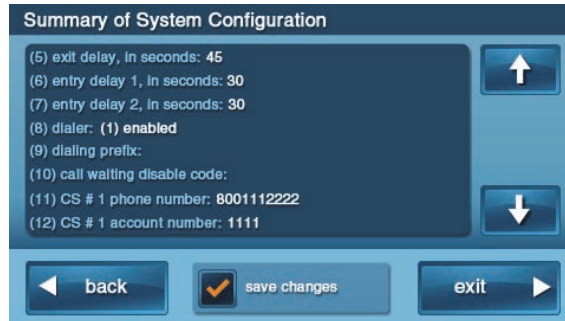

- 3 To save the programming changes, be sure the Save Changes option is checked. To exit without saving programming changes un-check the **Save Changes** option (for verification, an additional confirmation screen appears). Press **Exit**.
- 4 The Control Panel takes a few seconds to restart and display the Home screen.

Customizing the Installation

After programming the Control Panel, go to the User Toolbox and customize the system to suit the installation. To access the User Toolbox, do the following:

- 1 From the **Home** screen, press **Security**.
- 2 From the Security screen, press, **Menu**.
- 3 From the Menu screen, Press **Toolbox**.
- 4 Enter the *master user code* (the default master user code is 1111).
- 5 Press **User Management**.
- 6 To add, change, or delete a user code, press a **User #** button. The system asks to confirm the code entered. Be sure to set a Duress Code as User #8.



NOTE: User codes 0000, 0001, and the Installer Code are not permitted.

- 7 Setup each user code with the User Access Option screen. Each User Code can be set to be currently valid

or not, or to have conditional validity. Refer to the *User Guide* for details on setting User Code Access Schedules. When done, press **Back**.

- 8 Press **Brightness/Volume**. Set the level for the display brightness. Set the chime & voice volume. When done, press **OK**.

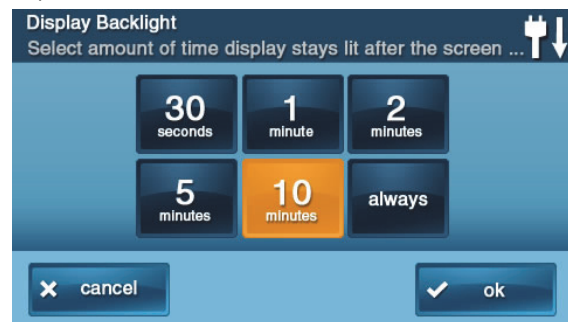

- 9 To view the 2nd Toolbox screen, press →. To set the display lighting timeout, press **Back Light Timeout**. Choose the length of time that the display will remain lit *after it is idle*. When done, press **OK**.
- 10 To set the calendar and the clock press **Set Date** and **Set Time**.



On the Set Date screen, use the ↓ and ↑ arrows to set the month, day, and year. On the Set Time screen, use the ↓ and ↑ arrows to set the hours, minutes, and AM/PM. When done, press **OK**. A confirmation screen appears. Verify the time and date, then press **OK** again.

- 11 If the GSM (Cellular) Radio Module is properly installed and registered, the system automatically sets the date and time.
 - To return to the **Security** screen, press **Back**.
 - OR
 - To return to the Home screen, press the  button.

INSTALLER TESTING

When installation and programming is complete, use the option in the Installer Toolbox to test for proper system operations.

ACCESS THE INSTALLER TOOLBOX

To access the Installer Toolbox:

- 1 At the **Home** screen, press the logo in the lower-right corner.
- 2 At the **Enter a Code** screen, enter the installer code (the default installer code is 1561).

The **Installer Toolbox (1 of 3)** screen appears.

DISABLE/ENABLE STATUS

When testing the Control Panel, both the internal and external sounder (if installed) will be activated. To limit noise during the testing process, the Control Panel offers an option to disable the sounder.

Disable the Sounder

To disable the sounder:

- 1 At the **Installer Toolbox** screen, press **Disable Sounder**.
- 2 At the **Disable Sounder** screen, press **OK**.

NOTE: The internal sounder emits a siren for two (2) seconds. If an external sounder is connected, four (4) chirps are emitted.

- 3 At the **Sounder Disabled** screen, press **OK**. The sounder will be automatically re-enabled in 30 minutes or you can manually enable it. See *"Enable the Sounder"* on page 68.
- 4 While disabled, the **Sounder Disabled** icon appears in the status bar.

Figure 56 Enable Sounder button

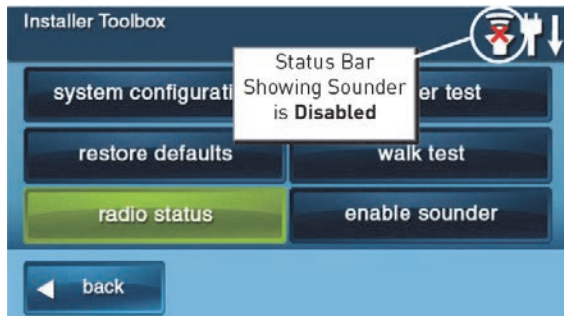

Enable the Sounder

If the sounder is disabled, you can manually re-enable it as follows:

- 1 At the **Installer Toolbox** screen, press **Enable Sounder**. See *Figure 56 Enable Sounder button*.
- 2 At the **Sounder Enabled** screen, press **OK**.

SENSOR TYPE (ZONE) REPORT TEST

To verify that the Central Station correctly receives reports from each zone (sensor type):

- 1 **Notify the Central Station.** Because the system sends test signals, notify the Central Station that you will be testing the system.

- 2 **Fire Test.** Trigger a 24-Hour fire sensor (if installed) or press the Control Panel's **Emergency** (+) button and then press the **Fire** button (if enabled). Wait for approximately 45 seconds for the report to complete, then disarm the console.
- 3 **Panic Test.** Trigger a 24-Hour Panic sensor (if installed) or press the Control Panel's **Emergency** (+) button and then press the **Panic** button (if enabled). Wait about 45 seconds for the report to complete, then disarm the console.
- 4 **Emergency Test.** Trigger a 24-Hour emergency sensor (if installed) or press the **Emergency** (+) button (if enabled), wait about 45 seconds for the report to complete, then disarm the console.
- 5 **Burglary Test.** Arm the system, then trigger a burglary sensor, wait for the system to go into alarm mode, then wait about 45 seconds for the report to complete, and then disarm the console.
- 6 **Verify Tests with Central Station.** Check with the Central Station that each zone (sensor type) was reported, then inform the Central Station that the testing is complete.

WALK TEST

Place the Control Panel into Walk Test mode to verify and test RF reception and signal strength for each sensor. A Walk Test also checks the Control Panel's indicators and sounder.

NOTE: Walk Test mode automatically ends after 25 minutes.

Signal Strength Indicators

While the Control Panel's RF receiver is highly-sensitive, reception quality can vary at times due to the amount of background RF noise on the receiver's operating frequency. To determine the best location for mounting the sensors, perform a Walk Test to view the signal strength indicators.



To identify sensors with weak signals, perform a Walk Test to show the signal strength from each sensor's RF transmission. For best results, it is recommended that you perform the test and then mount or re-mount each sensor in a location showing higher signal strength.

NOTE: Starting Walk Test mode sends a "Start Test" report to the Central Station. Stopping the Walk Test mode sends a "Stop Test" report to the Central Station.

Performing a Walk Test

To perform a Walk Test:

- 1 At the **Installer Toolbox** screen, press the **Walk Test** button.

NOTE: For the 25 minutes that the system is in Walk Test mode, the system beeps once every 30 seconds. During the last five (5) minutes, the system beeps two (2) times every 30 seconds. The **T** icon also flashes in the status bar.

- 2 Press the ↓ and ↑ arrows to scroll through the sensor list.
- 3 Activate the first sensor in the list and review the result on the screen:
 - When a sensor is received by the Control Panel, three (3) beeps occur and the display lights a green bar to the left of the sensor’s name.
 - The received signal strength of the sensor displays as one to five green bars. The more bars, the higher the signal strength.
 - If the signal level is sufficient, a check mark displays for that sensor.
 - If the signal level is insufficient or the signal test fails, the display lights a red bar, and an “x” displays for that sensor.



- For sensors with multiple loops, wait 15 seconds between triggering each loop.
- 4 Continue testing with each of the other sensors listed. After all the sensors have been tested, press **OK** to test the Control Panel’s indicators and sounder.
 - 5 Press each test item displayed, observe the Control Panel item being tested, and answer the **YES/NO** test question.
 - 6 When all sensors and devices have been tested, press **OK**. The Control Panel displays a summary of the test results. To return to the **Installer Toolbox** screen, press **OK**.



RADIO STATUS TEST

If the GSM (Cellular) Radio Module is installed in the Control Panel, use the **Radio Status** screen to view signal strength, serial number, registration status, and other information for the cellular connection. This is a helpful tool to use when troubleshooting the installation.

Cell Phone Test

To perform a cell phone test:

- 1 At the **Installer Toolbox** screen, press the **Radio Status** button.
- 2 In the **Radio Status** screen, press the **Cell Phone Test** button.

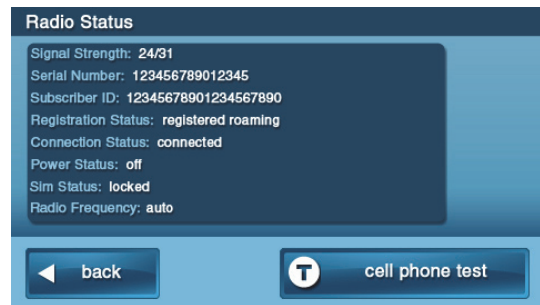

- 3 At the **Enter Master Code to Access Cell Phone Test** screen, enter the master user code.

The Cell Phone Test screen appears

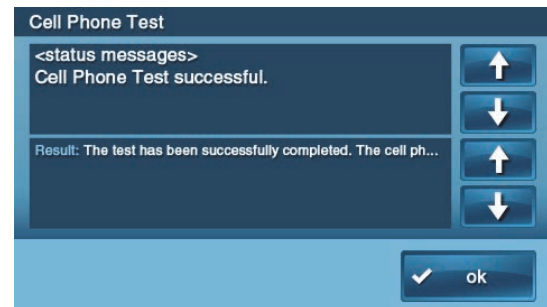

The top area of the **Telephone Test** screen shows the Control Panel actions and the bottom area shows the results.

- 4 Press the ↓ and ↑ arrows to review the actions and results:
 - RED text indicates the tested signal strength is zero, too low, or that the GSM (Cellular) Radio Module is unregistered.
 - ORANGE text indicates the connection is idle and the GSM (Cellular) Radio Module is registered.
 - GREEN text indicates good signal strength is good and the GSM (Cellular) Radio Module is registered.
- 5 When successful, press **OK** to return to the **Toolbox (3 of 3)** screen.

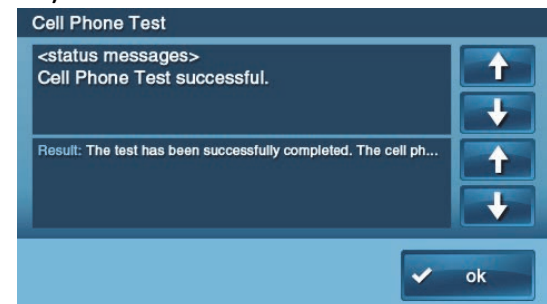

Telephone Test

Use this test to verify the land-line connection from the panel's built-in digital communicator and Central Station.

- 1 At the **Toolbox (3 of 3)** screen, press the **Telephone Test** button.

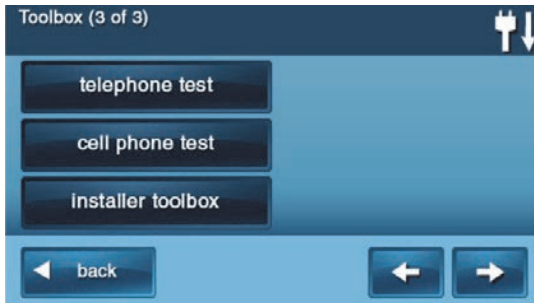

- 2 At the **Enter Master Code to Access Telephone Test** screen, enter the master code.
The top area of the **Telephone Test** screen shows the Control Panel actions and the bottom area shows the results.
- 3 Press the ↓ and ↑ arrows to review the actions and results.
- 4 When complete, press **OK** to return to the **Toolbox (3 of 3)** screen.

RESTORE DEFAULT SYSTEM CONFIGURATION

You can restore the Control Panel settings back to its factory defaults. There are two (2) types of reset options: *Soft* and *hard*.

Soft Reset

A *soft-reset* lets you select which settings to restore back to the factory defaults.

To perform a soft-reset:

- 1 At the **Installer Toolbox** screen, press the **Restore Default** button.

The Restore Default System Configuration screen appears.

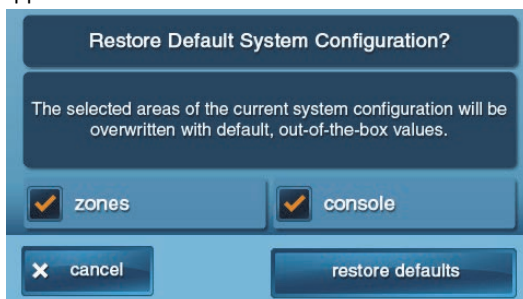

- 2 At the **Restore Default System Configuration** screen, select one or both checkboxes:
 - 2a **Zones.** Place a checkmark in this box to replace data for ALL sensors with the factory default values.

AND/OR

 - 2b **Console.** Place a checkmark in this box to replace all of the programming answers with the factory defaults. This erases the user codes, resets the backlight timeout to five (5) minutes, and resets the Brightness/Volume settings.

IMPORTANT: This action does not restore factory default settings for Z-Wave questions *Q79-Q83*.

Hard Reset

A *hard-reset* restores all of the programming settings back to the factory defaults.

NOTE: Before performing a hard reset, *Q44: Lock Installer Programming* must be set to option (1) or (2) and *Q45: Lock Default Programming* must be set to (0). See "*Q44: Lock Installer Programming (0-2)*" on page 60.

To perform a hard reset:

- 1 Remove the Control Panel cover and completely disconnect all power to the Control Panel.
- 2 On the inside back of the Control Panel, plug in the backup battery.
- 3 Press and hold down the **Emergency** (+) and **Home** buttons.
- 4 Continue to hold down the **Emergency** (+) and **Home** buttons and then connect DC Power to the Control Panel.
- 5 Release the buttons only after both the **Emergency** (+) and **Home** buttons are lit and the Control Panel screen appears.

REGULATORY INFORMATION

WIRELESS PRODUCT NOTICE

Radio controls provide a reliable communications link and fill an important need in portable wireless signaling; however, there are some limitations which must be observed.

- For U.S. installations only: The radios are required to comply with FCC Rules and Regulations as Part 15 devices. As such, they have limited transmitter power and therefore limited range.
- A receiver cannot respond to more than one transmitted signal at a time and may be blocked by radio signals that occur on or near their operating frequencies, regardless of code settings.
- Changes or modifications to the device may void FCC compliance.
- Infrequently used radio links should be tested regularly to protect against undetected interference or fault.
- A general knowledge of radio and its vagaries should be gained prior to acting as a wholesale distributor or dealer, and these facts should be communicated to the end users.

FCC NOTICE

This equipment generates and uses radio frequency energy and if not installed and used properly, that is, in strict accordance with the manufacturer's instructions, may cause interference to radio and television reception. It has been type tested and found to comply with the limits for a Class B computing device in accordance with Part 15 of FCC Rules, which are designed to provide reasonable protection against such interference in a residential installation. However, there is no guarantee that interference will not occur in a particular installation. If this equipment does cause interference to radio or television reception, which can be determined by turning the equipment off and on, the user is encouraged to try to correct the interference by one or more of the following measures:

- Relocate the Console away from the TV/radio receiver.
- Plug the Console into a different wall outlet so that the Console is on a different branch circuit.
- Re-orient the TV/radio antenna.
- If necessary, the user should consult the dealer or an experienced radio/television technician for additional suggestions.

FCC Telephone Rules and Regulations

The FCC requires that this alarm dialer system not make more than 15 repetitive dialing attempts to a single telephone number. There are no limitations when the calls are made sequentially to two or more alternative numbers, or when these calls are spaced 10 minutes apart to a single number. The FCC Rules and Regulations do not specify the re-attempt period as this can vary for specific applications. When setting this period, take into consideration local, interstate, foreign and special network call completion characteristics, network processing time, a sufficient number of rings and busy/don't answer modes.

Industry Canada Notices

NOTICE: The Ringer Equivalence Number (REN) assigned to each terminal device provides an indication of the maximum number of terminals allowed to be connected to a telephone interface. The termination on an interface may consist of any combination of devices subject only to the requirement that the sum of the ringer equivalence numbers of all the devices does not exceed five (5).

NOTICE: The Industry Canada label identifies certified equipment. This certification means that the equipment meets certain telecommunications network protective, operational and safety requirements. The Department does not guarantee the equipment will operate to the user's satisfaction.

Before installing this equipment, users should ensure that it is permissible to be connected to the facilities of the local telecommunications company. The equipment must also be installed using an acceptable method of connection. The customer should be aware that compliance with the above conditions may not prevent degradation of service in some situations.

Repairs to certified equipment should be made by an authorized Canadian maintenance facility designated by the supplier. Any repairs or alterations made by the user to this equipment, or equipment malfunctions, may give the telecommunications company cause to request the user to disconnect the equipment.

Users should ensure for their own protection that the electrical ground connections of the power utility, telephone lines and internal metallic water pipe system, if present, are connected together. This precaution may be particularly important in rural areas.

CAUTION: Users should not attempt to make such connections themselves, but should contact the appropriate electric inspection authority, or electrician, as appropriate.

Commercial Regulatory Listings

IMPORTANT: If this installation is a commercial installation, please inform the customer (or end user) that commercial Control Panels are for use only as burglar alarm systems and not for fire protection.

NOTE: The standard backup battery that is included with all 2GIG Control Panels does not support UL 985 installations. To comply with the secondary supply requirement in *UL 985 Household Fire Warning System Units*, you must install the 2GIG Console Battery Pack (2GIG-BATT2X).

IMPORTANT:

All conductors and attachments are manufactured in accordance with the Standard for *UL 681: Installation and Classification of Burglar and Holdup Alarm Systems*. The Control Panel contains hard wiring that is protected and not exposed. All conductors and attachments are manufactured in accordance with the *UL 681: Installation and Classification of Burglar and Holdup Alarm Systems*.

Stranded conductors clamped under wire-binding screws or similar parts shall have the individual strands soldered together or arranged in a construction that has been determined to be the equivalent.

IMPORTANT: A local alarm sounding device, alarm housing, and control unit shall comply with the mercantile requirements in *UL 365: Police Station Connected Burglar Alarm Units and Systems*.

LIMITED WARRANTY

This Linear product is warranted against defects in material and workmanship for one (1) year. This warranty extends only to wholesale customers who buy direct from Linear LLC or through Linear LLC's normal distribution channels. Linear LLC does not warrant this product to consumers. Consumers should inquire from their selling dealer as to the nature of the dealer's warranty, if any.

There are no obligations or liabilities on the part of Linear LLC for consequential damages arising out of or in connection with use or performance of this product or other indirect damages with respect to loss of property, revenue, or profit, or cost of removal, installation, or reinstallation. All implied warranties for functionality, are valid only until the warranty expires. This Linear LLC Warranty is in lieu of all other warranties expressed or implied.

2GIG by Linear

1950 Camino Vida Roble, Suite 150
Carlsbad, CA 92008 USA

For technical support in the USA and Canada:

855-2GIG-TECH (855-244-4832)
Email: 2gigtechsupport@linearcorp.com
Visit web site for technical support hours of operation

For technical support outside of the USA and Canada:

Contact your regional distributor
Visit dealer.2gig.com for a list of distributors in your region

77-000063-001 Rev. A



THIS PAGE INTENTIONALLY LEFT BLANK

THIS PAGE INTENTIONALLY LEFT BLANK



TECHNICAL SUPPORT
855.2GIG.TECH (855.244.4832)

YOUR LOCAL ALARM AND SERVICE PROFESSIONAL:

